

SINGLE-WIDTH FANS WITH ACOUSTAFOIL®/BC/PLR WHEELS

- Capacities to 200,000 CFM
- Three wheel choices
- Static pressures to 14"WG
- Class 1, 2, 3 construction

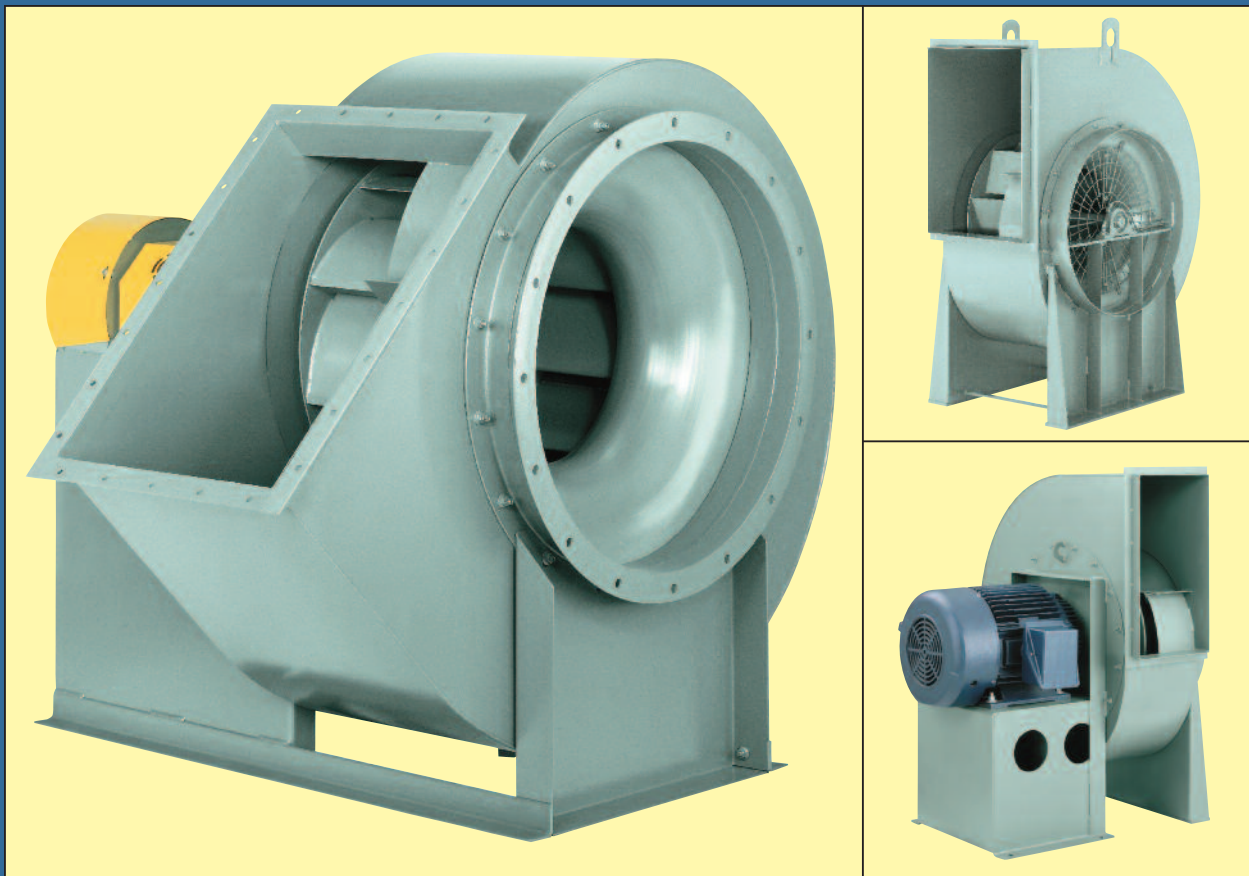

THE NEW YORK BLOWER COMPANY
7660 Quincy Street
Willowbrook, IL 60527-5530

Visit us on the Web: <http://www.nyb.com>
Phone: (800) 208-7918 Email: nyb@nyb.com

SINGLE-WIDTH FANS

New York Blower's Single-Width Fans are designed for a wide range of applications from commercial-building ventilation to industrial dust-collection systems. Three classes of construction combined with three wheel designs provide the utmost in selection choice.

DESIGN FEATURES

- Three wheel choices:
High-efficiency AcoustaFoil® wheels, Sizes 12"-73".*
Versatile backward curved wheels, Sizes 18"-73".
Rugged PLR backward inclined wheels, Sizes 12"-73".*
 - Capacities to 200,000 CFM.
 - Pressures to 14"WG.
 - Complete AMCA Class 1, 2, and 3 performance.*
 - Efficiencies beyond 85%.
 - Temperatures to 650°F.
 - Choice of direct-drive [see page 6] or belt-drive [see page 7] arrangements.
 - Available in clockwise and counterclockwise rotations in any of seven standard discharge positions.
- * See pages 6 and 7 for additional sizes and classes.

CONSTRUCTION FEATURES

- Heavy-gauge welded components provide structural strength and durability.
- Continuously welded housings provide the strongest possible construction.
- Shafting is straightened to close-tolerance to minimize "run out" and ensure smooth operation.
- Lifting eyes are standard on all fans.
- Wheels are dynamically balanced and all fans are checked at the specified running speed.
- Bearings are selected to provide long service life through the entire operating range of the fan.

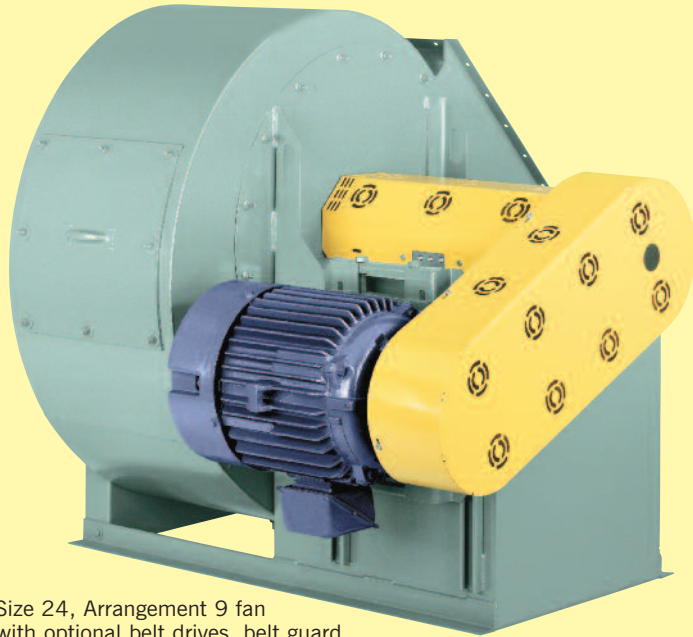

Size 24, Arrangement 9 fan with optional belt drives, belt guard, shaft and bearing guard, flanged outlet, bolted cleanout door, and motor.

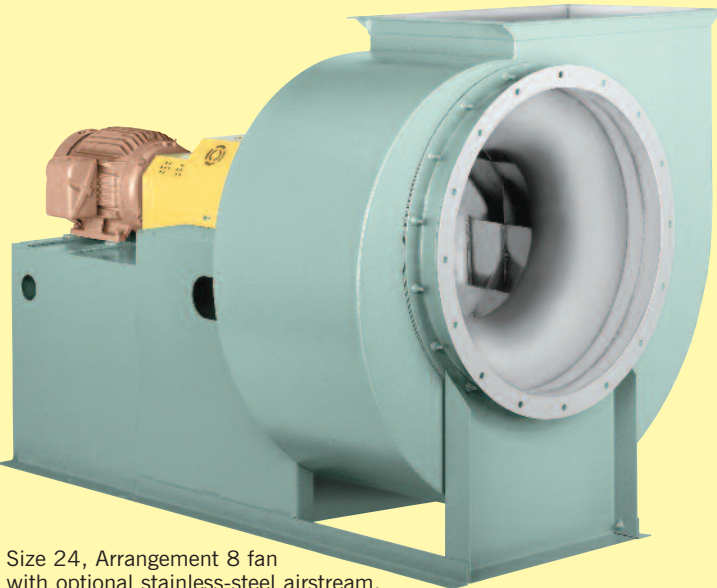

Size 24, Arrangement 8 fan with optional stainless-steel airstream, flanged inlet, flanged outlet, shaft and bearing guard, coupling, coupling guard, and motor.



The New York Blower Company certifies that the Single-Width AcoustaFoil Fans shown on pages 10 through 12 and Single-Width PLR Fans shown on pages 15 through 17 are licensed to bear the AMCA Seal. The ratings shown are based on tests and procedures performed in accordance with AMCA Publication 211 and comply with the requirements of the AMCA Certified Ratings Program.

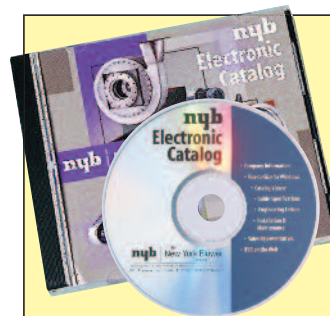

ELECTRONIC CATALOG

A complete windows-based Electronic Catalog is now available on disk to assist in fan selection. See details on page 10.

CHOICE OF 3 WHEEL DESIGNS

Three wheel designs provide the widest choice in application suitability, efficiency, sound, and cost. All three feature the backward-inclined, non-overloading horsepower characteristic where the horsepower reaches a peak and then decreases even as flow increases. This characteristic allows maximum brake horsepower calculation and motor selection that prevents electrical system overloading even if system pressure changes.

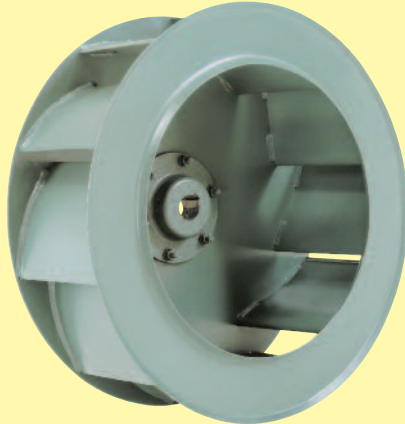
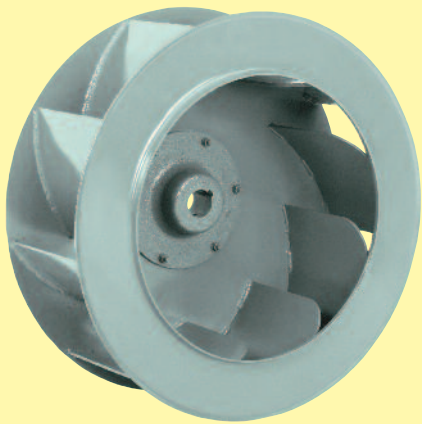
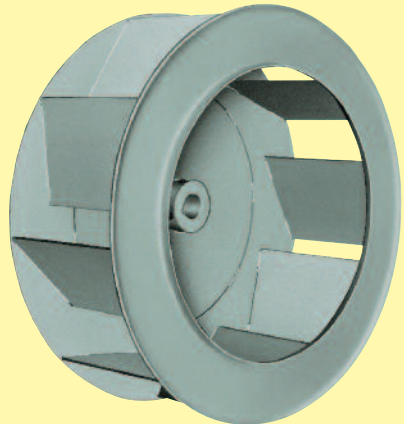
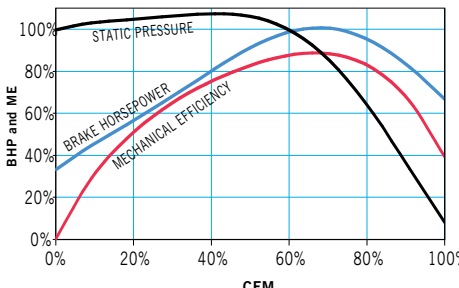
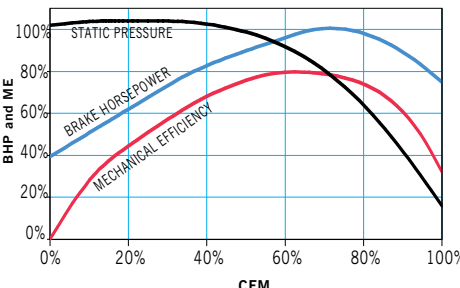
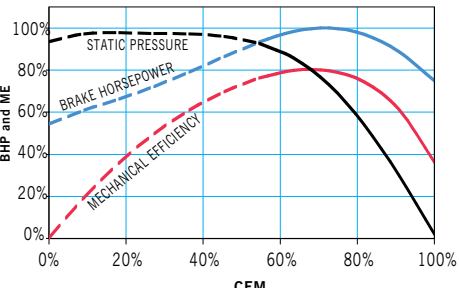
		
<h2>ACOUSTAFOIL</h2>	<h2>BACKWARD CURVED</h2>	<h2>PLR</h2>
<h3>WHEEL DESIGN</h3>		
<p>True aerodynamic airfoil-blade shape allows stable operation from wide-open to closed-off. Ideal for clean-air applications such as building ventilation with variable-air-volume system control or clean industrial-gas-handling.</p>	<p>Aerodynamic, single-surface blade shape offers alternative selection points to the AcoustaFoil for building ventilation and industrial gas-handling. Backward curved wheels also provide stable operation from wide-open to closed-off.</p>	<p>Flat, single-thickness, backwardly inclined blades are suited to applications from clean air to those where dust and limited material is present in the airstream and airfoil shapes are not recommended due to material build-up.</p>
<h3>EFFICIENCY</h3>		
<p>Dual aerodynamically designed blade surfaces provide the most efficient design of all wheel types. In addition, the AcoustaFoil design offers a broad peak efficiency range for selection.</p>	<p>Curved, single-thickness blade surface generates efficiency levels approaching the AcoustaFoil but with alternative operating points for greater choice.</p>	<p>Peak efficiency point is on the steeply rising portion of the pressure curve and vastly superior to forward curved and radial wheel designs.</p>
<h3>SOUND</h3>		
<p>Because of superior efficiency, AcoustaFoil wheels generate the lowest sound levels over a wide range of performance.</p>	<p>The backward curved wheel offers low sound levels approaching that of the AcoustaFoil.</p>	<p>Sound levels are the lowest with the most efficient fan selections.</p>
<h3>CONSTRUCTION</h3>		
<p>Sizes 12 and 15 available in welded aluminum only. Sizes 18 to 73 available in all-welded steel and optional aluminum and stainless steel.</p>	<p>Sizes 18 to 73 available in all-welded steel and also optional aluminum.</p>	<p>Sizes 12 to 73 available in all-welded steel and also optional aluminum and stainless steel.</p>
<h3>PERFORMANCE</h3>		
		

ACCESSORIES



Size 24, Arrangement 9 fan with optional inlet box, flanged inlet and outlet, outlet damper, shaft and bearing guard, belt guard, bolted cleanout door, and motor.

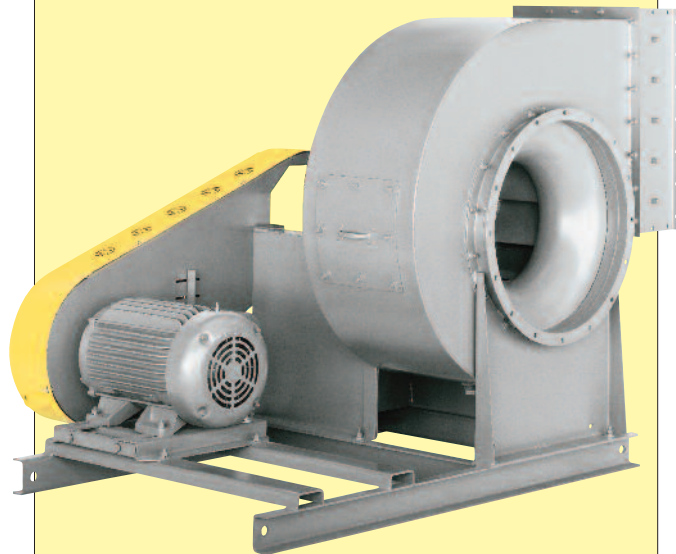

Size 22, Arrangement 1 fan with optional unitary base, flanged inlet and outlet, discharge damper, shaft and bearing guard, bolted cleanout door, motor and slide base, and gray epoxy coating.

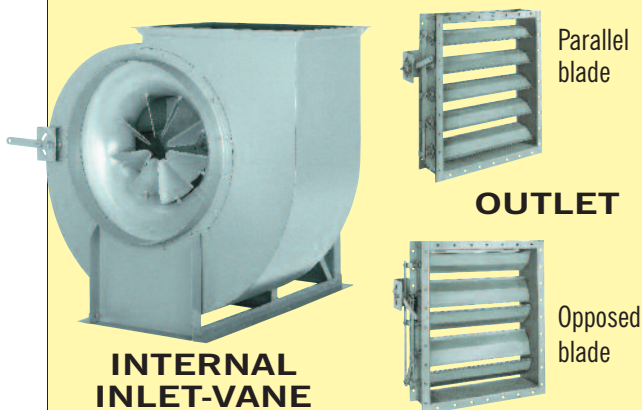

FLANGES

Outlet flange angles welded flush with fan outlet and provided with holes...**inlet flange** angle ring welded to inlet collar and provided with holes...**companion flange** with matching hole pattern also available.

DRAIN

Welded tank flange, 1" on sizes up to 15 ...1½" on Sizes 18 and larger, located at the lowest point in the housing scroll.



SHAFT SEAL

Ceramic-felt seal elements are encased between metal backing plate and retaining disc...elements can be easily split for field installation and maintenance...lubricated lip seals are also available.



UNITARY BASE

Structural steel or formed channel base provides common support for fan, motor, and drive components...also available with **spring-type** or **rubber-in-shear isolators**...flexible duct connections are recommended for use with isolation bases.

INLET BOX

Minimizes entry losses normally associated with 90° turns at or near fan inlet...also available with parallel-blade damper for efficient volume control...refer to separate Catalog Sheet.

CLEANOUT DOOR

Three types of gasketed doors are available...**quick-opening**: latch-type door swings open on hinges after turning cam levers...**bolted**: closely spaced studs keep door securely sealed...**raised bolted**: allows for insulation when desired, door raised 2" from the fan housing.

SAFETY EQUIPMENT

Belt guards, shaft and bearing guards, coupling guards, inlet guards, and outlet guards are available.

DAMPERS

Internal inlet-vane—available in Sizes 18 and larger...allows smooth control in systems that require efficient dampening of airflow...damper is an integral part of the fan inlet cone providing considerable space savings...quick-opening cleanout door is furnished that will provide easy access to linkage components...external inlet-vane dampers are also available. See separate Engineering Supplement for detailed performance characteristics.

Parallel-blade and opposed-blade outlet—available for volume-control applications at temperatures to 650°F. See Catalog Sheet and Engineering Letter.

MODIFICATIONS

HANDLING CORROSIVES

Protective coatings, special alloys, and FRP construction are available to combat corrosion problems.

Special coatings [up to 12 mil thickness]—special paints and spray coatings are available under a variety of trade names. **nyb** works with experienced coating applicators who can apply coatings to meet a wide range of requirements.

Alternate-material construction—Single-Width Fans can be constructed of aluminum or various stainless steels.

HEAT-FAN CONSTRUCTION

Arrangement 1, 8, and 9 fans can be constructed for elevated-temperature operation with the addition of shaft cooler and guard and high-temperature paint for 650°F. maximum airstream temperature. Arrangement 9 fans are also furnished with motor heat shield. If optional shaft seal is selected, a recessed cone is furnished. Note that the maximum safe wheel speeds decrease as airstream temperatures increase...see Chart I on page 9.

SPARK-RESISTANT CONSTRUCTION [SRC]

Intended to minimize the potential for any two or more fan components to generate sparks within the airstream by rubbing or striking during operation.

The following types are available:

AMCA A [AIRSTREAM] SRC

To include all airstream parts constructed of a spark-resistant alloy...maximum temperature: 200°F.

AMCA B [WHEEL] SRC

To include the fan wheel constructed of a spark-resistant alloy and a buffer plate around the housing shaft-hole opening...maximum temperature: 200°F.

AMCA C [BUFFER] SRC

To include a spark-resistant alloy buffer affixed to the housing interior adjacent to the wheel backplate, a spark-resistant alloy inlet cone, and a buffer plate around the housing shaft-hole opening...maximum temperature: 650°F

ALL TYPES SRC

Fan is to be so constructed such that no bearings, drive components, or electrical apparatus are located in the airstream...the user must electrically ground all fan and system components.

Refer to Engineering Letter 15 for the full meaning and limits of spark-resistant construction.

FRP FANS

nyb manufactures a complete line of fiberglass-reinforced plastic fans for applications requiring the handling of corrosive fumes...see separate bulletins.



SPLIT-HOUSING CONSTRUCTION

Available with standard construction for:
Sizes 40-73 Class I and II
Sizes 36-73 Class III
Sizes 36-73 Class I, II, and III Arrangement 3

TYPE A

**Bottom Horizontal
Up Blast
Down Blast**

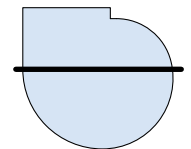

Horizontal split allows removal of top section without disturbing inlet connection...outlet connection must be broken on Up Blast fans only.

TYPE B

**Top Horizontal
Top Angular Down
Bottom Angular Up
Top Angular Up**

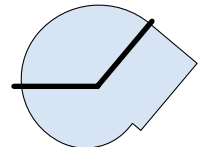

Split allows removal of pie-shaped section without disturbing inlet or outlet connections.

SAFETY EQUIPMENT

Safety accessories are available from **nyb**, but selection of the appropriate devices is the responsibility of the system-designer who is familiar with the particular installation, or application, and can provide for guards for all exposed moving parts as well as protection from access to high-velocity airstreams. Neither **nyb** nor its sales representatives is in a position to make such a determination. Users and/or installers should read "Recommended Safety Practices for Air Moving Devices" as published by the Air Movement and Control Association International, Arlington Heights, Illinois.

DIRECT-DRIVE ARRANGEMENTS

See Catalog Sheet CS 135, Arrangement 4 fans, and Bulletin 161, Class 4 Fans, for additional information on these models including performance, dimensions, and limitations.

APPLICATION CONSIDERATIONS

As compared to belt-drive fan arrangements, direct-drive Arrangement 4 fans of all styles, where the fan wheel mounts directly onto the motor shaft, are more compact, require less maintenance, and generally have a lower first cost. However, relative to belt-drive fans, they are limited in application, size, available features, and the ability to adjust performance. Direct-drive Arrangement 8 fans offer much of the flexibility of belt-drive fans and are even preferred in systems that require large volumes of air and are over 250-300 HP due to drive limitations.

A major objection to direct-drive arrangements in the past was the inability to adjust fan speed if system requirements changed. With the advent of variable frequency drives (VFDs) the speed, and therefore performance, of direct-drive fans can now be adjusted to meet varying requirements. See page 8 for additional fan-control information. Given the variety of operating speeds available, choices in wheel width, and its effect on wheel safe speed limits, the only cost-effective method for selecting today's direct-drive fans is software selection programs such as New York Blower's Electronic Catalog.

SIZE/ARRANGEMENT AVAILABILITY

Wheel	Class	Arrangement				
		4	4-F	4-H	4-V	8
AcoustaFoil	1	–	–	–	–	12-73
	2	10-33	10-33	10-22	10-33	12-73
	3	16-33	16-33	16-22	16-33	18-73
	4	20-27	20-27	20-22	20-27	18-73
BC	1	–	–	–	–	18-73
	2	18-33	18-33	18-22	18-33	18-73
PLR	1	–	–	–	–	12-73
	2	10-33	10-33	10-22	10-33	12-73
	3	16-33	16-33	16-22	16-33	18-73
	4	20-27	20-27	20-22	20-27	18-73

Wheel diameter in inches.

ELECTRONIC CATALOG

Fan-selection program corrects for altitude, temperature, rarefaction, adjusts maximum safe speed for wheel width, and generates performance curves. See details on page 10.

ARRANGEMENT

4

Traditional arrangement utilizing fan pedestal and foot-mounted motor. Seven discharge positions are available to meet requirements.

Max. temperature: 180°F.



ARRANGEMENT

4-F

Most compact arrangement with motor mounting directly to housing and fan flush-mounted to the customer's mating surface.

Max. temperature: 120°F.

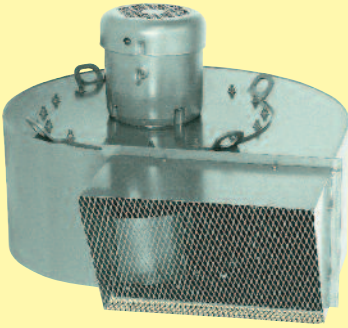

ARRANGEMENT

4-H

Designed for mounting so the fan shaft is horizontal. Motor mounts directly to the fan housing. Fan is flange-mounted to the customer's mating surface.

Max. temperature: 120°F.



ARRANGEMENT

4-V

Similar to the 4-F. Designed for mounting so the fan shaft is vertical. Motor mounts directly to fan housing. Fan is flange-mounted to the customer's mating surface.

Max. temperature: 120°F.



ARRANGEMENT

8

Integral pedestal furnished for the motor and coupling. Most flexible of the direct-drive arrangements allowing for larger motors, fan sizes, and accessories.

Standard max. temp.: 300°F.
Heat fan max. temp.: 650°F.

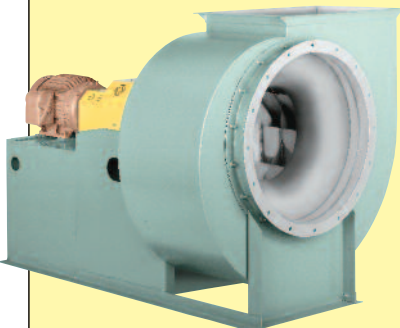

BELT-DRIVE ARRANGEMENTS

See Bulletin 051, General Purpose Packaged Fans, for additional information on Arrangement 10 models including performance, dimensions, and limitations.

APPLICATION CONSIDERATIONS

As compared to direct-drive fan arrangements, belt-drive fans, where the fan wheel is supported by a shaft and bearings and driven by belts, allow for a wider range of sizes and applications, and offer a greater selection of accessories and modifications. However, relative to direct-drive fans, they have a larger footprint for a given fan size and have a higher first cost. Without additional controls, belt-drive fan performance can be easily altered in the field by changing sheaves and belts. Because of the numerous choices available between belt-drive and direct-drive arrangements, it is recommended that you consult your New York Blower representative for selection guidelines.

SIZE/ARRANGEMENT AVAILABILITY

Wheel	Class	Arrangement			
		1	3	9	10
AcoustaFoil	1	12-73	24-73	12-73	-
	2	12-73	24-73	12-73	12-36
	3	18-73	24-73	18-73	-
	4	18-73	30-73	-	-
BC	1	18-73	24-73	18-73	-
	2	18-73	24-73	18-73	18-36
PLR	1	12-73	24-73	12-73	-
	2	12-73	24-73	12-73	12-36
	3	18-73	27-73	18-73	-
	4	18-73	30-73	-	-

Wheel diameter in inches.

ARRANGEMENT

1

Overhung wheel keeps bearings out of airstream. Motor mounts independently from fan. Greatest flexibility.

Standard max. temp.: 300°F.*
Heat fan max. temp.: 650°F.*



ARRANGEMENT

3

Wheel supported between bearings is compact and suitable for clean, dry-air service.

Max. temperature: 120°F.

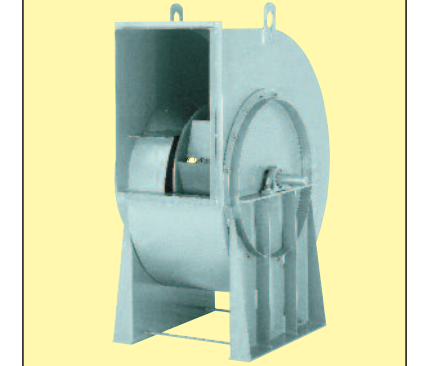

ARRANGEMENT

9

Similar to Arrangement 1 but with motor mounted on side of fan pedestal reducing overall size and field-installation costs.

Standard max. temp.: 300°F.*
Heat fan max. temp.: 650°F.*



ARRANGEMENT

10

Compact, packaged design with motor mounted within the fan pedestal. Minimum field installation labor required.

Standard max. temp.: 200°F.*
Heat fan max. temp.: 650°F.*



*Limit for Sizes 12 and 15 fans with AcoustaFoil wheels is 200°F.; heat-fan construction not available.

V-BELT DRIVES

In the lower horsepower ranges, V-belt drive selection is relatively simple, but as horsepower requirements increase, V-belt drive selection becomes more complicated and requires more consideration of the drive's effects on fan and motor bearings.

A few general recommendations to remember are:

- 3600 RPM motors are not generally recommended for belt-drive above 20 HP.
- 1800 RPM motors are not generally recommended for belt-drive above 300 HP.
- When motors 200 HP and larger are to be used with belt-drive fans, **nyb** requires that the motor manufacturer:
 - Recommend the minimum diameter motor sheave that may be used.
 - Recommend the maximum motor-sheave width that may be used.

With the above information from the motor manufacturer, the drive may be selected.

FAN ENGINEERING AND SELECTION

GENERAL

Fans are an integral part of the systems in which they are applied. As such, New York Blower sales representatives work closely with design engineers in assessing requirements and meeting critical performance and dimensional specifications. Because of the wide variety of choices available, it is recommended that selection be made using New York Blower's Electronic Catalog software and that a New York Blower sales representative assist in optimizing the final selection.

WHEEL SPEED VS. WIDTH

A major component in the determination of wheel maximum safe speed is blade strength. Narrower wheels are inherently stronger, permitting higher wheel maximum safe speeds. Using a variety of engineering tools such as a finite element analysis, New York Blower can now provide performance selections previously unavailable. For example, the direct-drive performance curves shown here illustrate maximum performance capabilities with full-width wheels [solid lines] and maximum performance capabilities with narrow-width wheels [dotted lines] at 70°F. Note that the pressure generating capability approximately doubles. Final selection of direct-drive fans can only be optimized using **nyb** Electronic Catalog software.

SIZE 30 CLASS II FAN PERFORMANCE

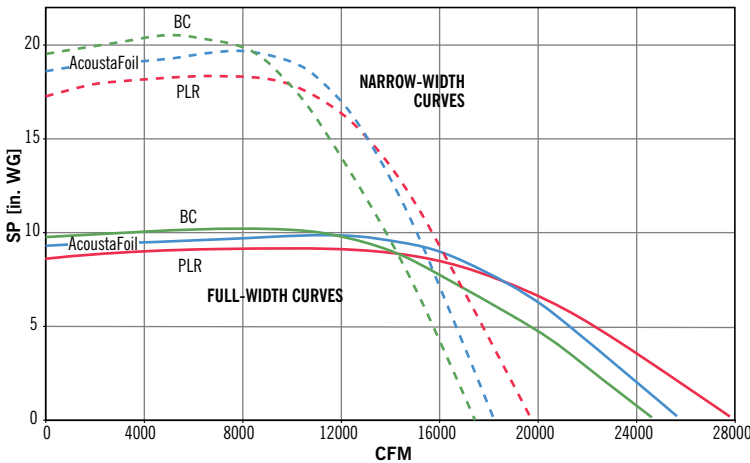

HEAT FANS

Fans handling hot airstreams must be kept in operation after system shutdown until the airstream cools below 200°F. to prevent damage to the fan. The fan wheel or shaft might otherwise distort due to "heat-soaking." The shaft cooler is only effective while rotating. Burners should be located so that the air is thoroughly mixed before entering the fan inlet. Improper placement could cause hot spots on the fan wheel which exceed maximum design temperatures. Contact **nyb** when the application involves temperature changes greater than 20°F per minute.

Refer to the selection example on page 9 for the effect of temperature on the maximum safe speed of wheels and the temperature derate factors in Chart I.

CAPACITY CONTROL

The rising cost of energy requires that air-handling systems be operated efficiently at less than maximum design airflow. The high efficiency and inherent stability of the AcoustaFoil wheel is particularly well-suited to variable airflow systems. The AcoustaFoil wheel design ensures not only maximum operating efficiency at design CFM but also at reduced airflow regardless of the control method applied. This higher efficiency allows quieter operation throughout the modulation range.

The New York Blower Company's nationwide network of trained sales representatives is familiar with each of these control alternatives and can offer further assistance in selecting the best control for a particular application.

INLET-VANE DAMPER CONTROL

Inlet-vane dampers affect the fan's output by spinning the air in the direction of wheel rotation. With this pre-spin, the wheel cannot develop its full output, yielding a reduced CFM at reduced horsepower. Each damper setting creates new pressure and horsepower curves. With inlet-vane dampers, reduced airflow always results in reduced horsepower.

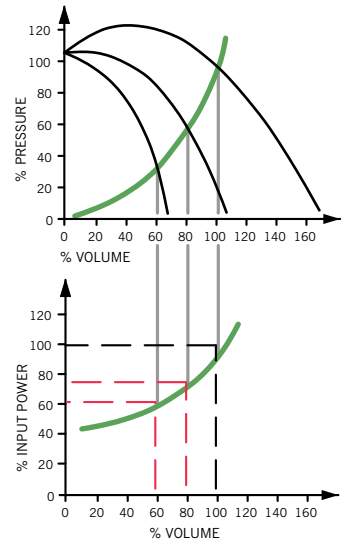

VARIABLE FREQUENCY MOTOR SPEED CONTROL

Variable frequency motor speed controllers provide energy savings by directly controlling fan speed. From the fan laws, CFM varies directly with the change in fan speed and horsepower varies by the change in fan speed cubed. For example, a 20% reduction in fan speed yields a 20% reduction in airflow and a 49% reduction in BHP. Controllers must have lockouts to prevent operation beyond the maximum safe speed of the fan.

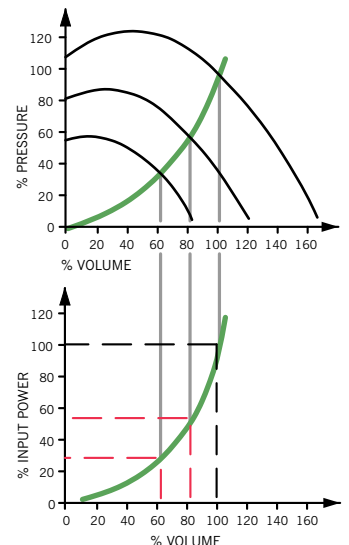

How to Use Performance Tables

For a given fan size, wheel design, CFM, and static pressure, performance tables can be used to obtain outlet velocity, fan RPM, and BHP. If capacities are at conditions other 70°F., sea level, or standard density [.075 lb./cu.ft.], correction factors must be applied to static pressure and BHP.

PROCEDURES	STEPS	EXAMPLE: A fan is required for 13,000 CFM at 4"WG at 600°F. and sea level.
If conditions other than standard are involved, correct static pressure for actual altitude and temperature using Charts II and III.	1	Chart II gives a 2.00 factor for 600°F. Corrected SP is 4"WG x 2.00 = 8"WG at 70°F. Select fan from performance tables for 13,000 CFM at 8"WG.
Select size, wheel type, RPM, and BHP of fan from performance table.	2	A Size 30 with AcoustaFoil wheel is selected for 13,000 CFM at 8"WG at 1650 RPM and 20.5 BHP.
Check maximum safe speed of fan at operating temperature as shown in the performance tables and Chart I.	3	From the performance table and Chart I, the maximum safe speed of a Size 30 fan with Class 2 AcoustaFoil wheel at 600°F. is 1660 RPM [1805 x .92]. Fan is satisfactory for operation at 600°F.
Determine actual performance at operating conditions by correcting SP and BHP.	4	Actual performance: 13,000 CFM at 4"WG [8" ÷ 2.00] at 1650 RPM at 10.3 BHP [20.5 ÷ 2] at 600°F.

PERFORMANCE CORRECTION FACTORS

Fan performance is based on actual feet per minute [ACFM] at the fan inlet at standard density [.075 lbs./ft.³] and static pressure at the fan outlet. Static pressure capabilities are shown in inches water gauge ["WG].

Air-density corrections are necessary for proper selection when air density varies from the standard .075 lbs./ft.³ at 70°F. at sea level. Multiply the required static pressure at operating conditions by the appropriate factors in Charts II and III to obtain the corrected static pressure for standard conditions. Pressure and BHP will be reduced at conditions by the inverse of these factors. Multiply one factor by the other if temperature and altitude are non-standard. For example: if the installation is located at an altitude of 4000 feet and the gas temperature is 300°F. the correction factor is 1.66 [1.16 x 1.43]. Temperature and altitude correction is made automatically using New York Blower's Electronic Catalog software.

MAXIMUM SAFE SPEED INFORMATION

Each performance table on pages 10-17 includes the maximum safe speed of the standard wheel at 70°F. Fan operation at temperatures above 70°F. primarily affects the strength of rotating components, which declines as temperature increases. When alloy construction is specified or when temperatures are involved, multiply the appropriate safe operating speed shown in the performance table by the factor shown in Chart I. Note that Sizes 12 and 15 AcoustaFoil wheels are aluminum as standard. Also that the maximum safe speeds apply only to wheels operated at or below 70°F. and are free of material build-up, corrosion, or wear. See discussion on page 8 regarding direct-drive fans and maximum safe wheel speeds for wheels that are narrow-width. Maximum wheel safe speeds are computed automatically using New York Blower's Electronic Catalog software.

CHART I

TEMPERATURE CORRECTION FACTORS FOR WHEEL OPERATING SPEEDS

Temp. °F.	Wheel material				
	Steel	Aluminum	Stainless 304*	Stainless 316*	Stainless 347*
-50	1.00	1.00	1.00	1.00	1.00
70	1.00	1.00	1.00	1.00	1.00
200	.97	.98	.88	.95	.95
300	.95	—	.82	.92	.93
400	.94	—	.78	.89	.90
500	.93	—	.75	.86	.90
600	.92	—	.73	.84	.90
650	.89	—	.71	.82	.90

*PLR Fans only.

CHART II

TEMPERATURE CORRECTION FACTORS (°F.)

Temp. °F.	Factor	Temp. °F.	Factor
-50	.77	250	1.34
-25	.82	275	1.39
0	.87	300	1.43
20	.91	325	1.48
40	.94	350	1.53
60	.98	375	1.58
70	1.00	400	1.62
80	1.02	450	1.72
100	1.06	500	1.81
120	1.09	550	1.91
140	1.13	600	2.00
160	1.17	650	2.10
180	1.21		
200	1.25		
225	1.29		

NOTE: When more than one correction is made, the factors are combined by multiplying factors.

CHART III

CORRECTION FACTORS FOR ALTITUDE [feet above sea level]

Altitude	Factor
0	1.00
500	1.02
1000	1.04
1500	1.06
2000	1.08
2500	1.10
3000	1.12
3500	1.14
4000	1.16
4500	1.18
5000	1.20
5500	1.22
6000	1.25
7000	1.30
8000	1.35
9000	1.40
10000	1.45

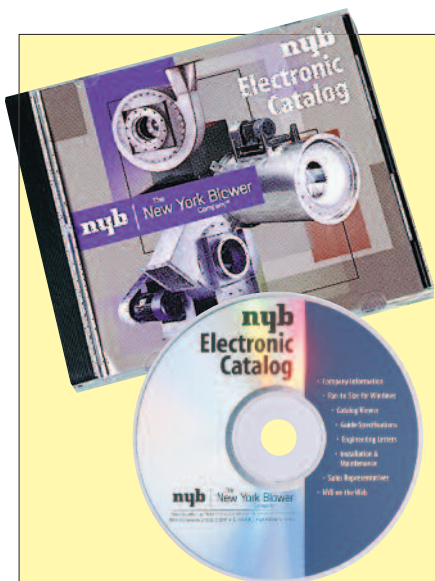

ELECTRONIC CATALOG

A complete New York Blower Catalog on one CD. No more manual calculations and bulky product catalogs. A critical tool for all system-designers and engineers who select and specify air-moving equipment.

SELECTION BENEFITS

- Fast, accurate fan selection.
- Automatic altitude, temperature, and density corrections.
- Sound levels by octave band.
- Fan-performance curves.
- Multiple model and size choices.
- Metric or English units.

CATALOG CONTENTS

- Fan-selection program.
- Complete product catalog in PDF including drawings, dimensions, and design specifications.
- Sample guide specifications.
- New York Blower Engineering Letters.
- Installation and Maintenance Manuals.
- Listing of New York Blower representatives.

To obtain your copy of New York Blower's Electronic Catalog contact your local New York Blower representative or go to www.nyb.com and click on *Selection/Engineering Tools*.

PERFORMANCE FOR SINGLE-WIDTH FANS WITH **ACOUSTAFOIL** WHEELS

SIZE 12	CFM	OV	1"SP		1½"SP		2"SP		3"SP		4"SP		5"SP		6"SP		7"SP		8"SP		
			RPM	BHP	RPM	BHP	RPM	BHP	RPM	BHP	RPM	BHP	RPM	BHP	RPM	BHP	RPM	BHP	RPM	BHP	RPM
Max. safe speeds Class 1=3755 RPM Class 2=4900 RPM	1000	1163	1714	0.53	1928	0.63	2120	0.74	2514	0.99	2895	1.29	3235	1.63	3526	1.97	3806	2.34	4066	2.77	
	1300	1512	1961	0.63	2160	0.75	2334	0.88	2642	1.15	2939	1.44	3241	1.78	3550	2.18	3837	2.61	4093	3.09	
	1600	1860	2242	0.77	2409	0.92	2574	1.07	2865	1.37	3122	1.70	3363	2.04	3607	2.41	3846	2.85	4095	3.36	
	1900	2209	2541	0.96	2689	1.12	2828	1.29	3105	1.65	3352	2.01	3571	2.39	3772	2.80	3979	3.28	4182	3.77	
	2100	2442	2748	1.11	2882	1.28	3013	1.47	3267	1.86	3509	2.25	3730	2.68	3923	3.14	4120	3.65	4303	4.15	
	2400	2791	3066	1.38	3189	1.58	3306	1.79	3530	2.22	3751	2.69	3972	3.20	4161	3.71	4342	4.24	4516	4.80	
	2700	3140	3391	1.73	3502	1.95	3605	2.17	3815	2.66	4012	3.22	4210	3.80	4406	4.37	4583	4.94	4749	5.52	
	3000	3488	3721	2.14	3819	2.38	3919	2.65	4109	3.23	4288	3.81	4465	4.44	4647	5.10	4823	5.73			

SIZE 15	CFM	OV	1"SP		1½"SP		2"SP		3"SP		4"SP		5"SP		6"SP		7"SP		8"SP		
			RPM	BHP	RPM	BHP	RPM	BHP	RPM	BHP	RPM	BHP	RPM	BHP	RPM	BHP	RPM	BHP	RPM	BHP	RPM
Max. safe speeds Class 1=2910 RPM Class 2=3800 RPM	1400	1085	1350	0.60	1536	0.74	1706	0.89	2014	1.23	2286	1.60	2541	2.02	2784	2.48	3007	3.02	3210	3.58	
	1800	1395	1527	0.71	1691	0.88	1841	1.05	2115	1.43	2362	1.84	2595	2.29	2811	2.80	3028	3.40	3220	3.99	
	2200	1705	1722	0.87	1867	1.05	2002	1.25	2254	1.68	2480	2.14	2692	2.64	2888	3.20	3083	3.82	3271	4.48	
	2600	2016	1927	1.06	2059	1.28	2185	1.51	2417	1.99	2622	2.48	2823	3.09	3001	3.69	3186	4.37	3354	5.04	
	3000	2326	2139	1.30	2264	1.55	2380	1.81	2592	2.34	2789	2.94	2966	3.58	3140	4.25	3311	4.98	3467	5.69	
	3400	2636	2357	1.60	2471	1.88	2581	2.17	2776	2.77	2962	3.46	3138	4.19	3298	4.91	3454	5.66	3609	6.46	
	3800	2946	2581	1.97	2687	2.28	2790	2.60	2975	3.32	3148	4.06	3313	4.85	3467	5.64	3611	6.42	3759	7.28	
	4200	3256	2807	2.41	2906	2.77	3001	3.16	3176	3.94	3345	4.77	3497	5.59	3641	6.42	3785	7.31			

SIZE 18	CFM	OV	1"SP		2"SP		3"SP		4"SP		6"SP		8"SP		10"SP		12"SP		14"SP		
			RPM	BHP	RPM	BHP	RPM	BHP	RPM	BHP	RPM	BHP	RPM	BHP	RPM	BHP	RPM	BHP	RPM	BHP	RPM
Max. safe speeds Class 1=2305 RPM Class 2=3005 RPM Class 3=3790 RPM	2000	1042	1028	0.69	1333	1.10	1605	1.60	1850	2.15	2287	3.56	2658	5.18	2996	6.99	3283	8.82	3562	10.9	
	2900	1510	1238	0.94	1467	1.42	1685	1.98	1888	2.61	2274	4.23	2613	6.01	2931	7.99	3225	10.1	3497	12.4	
	3800	1979	1482	1.33	1673	1.91	1850	2.54	2017	3.31	2339	5.04	2647	7.01	2937	9.17	3205	11.5	3468	13.9	
	4700	2448	1741	1.88	1910	2.60	2062	3.42	2203	4.26	2481	6.16	2744	8.23	3000	10.5	3248	13.0	3482	15.6	
	5600	2917	2009	2.63	2160	3.58	2293	4.52	2420	5.49	2668	7.60	2896	9.80	3123	12.2	3339	14.8	3549	17.4	
	6500	3385	2279	3.70	2421	4.86	2545	5.95	2661	7.06	2878	9.33	3088	11.8	3286	14.3	3482	17.0	3679	19.9	
	7400	3854	2554	5.06	2686	6.40	2801	7.67	2907	8.89	3106	11.4	3297	14.1	3479	16.8	3655	19.7			
	8300	4323	2833	6.75	2955	8.28	3063	9.72	3164	11.1	3351	14.0	3527	16.8	3691	19.7					

SIZE 22	CFM	OV	1"SP		2"SP		3"SP		4"SP		6"SP		8"SP		10"SP		12"SP		14"SP		
			RPM	BHP	RPM	BHP	RPM	BHP	RPM	BHP	RPM	BHP	RPM	BHP	RPM	BHP	RPM	BHP	RPM	BHP	RPM
Max. safe speeds Class 1=1970 RPM Class 2=2570 RPM Class 3=3240 RPM	3000	1053	846	0.88	1096	1.49	1321	2.23	1524	3.15	1864	5.23	2166	7.66	2430	10.3	2672	13.2	2885	16.1	
	4300	1509	1011	1.24	1203	1.97	1383	2.84	1556	3.90	1871	6.27	2149	8.90	2407	11.8	2640	14.9	2852	18.2	
	5600	1965	1205	1.79	1364	2.68	1512	3.75	1654	4.92	1922	7.47	2173	10.3	2415	13.5	2637	16.9	2839	20.4	
	6900	2421	1413	2.57	1551	3.75	1675	4.95	1797	6.26	2029	9.08	2247	12.1	2457	15.4	2666	19.1	2863	23.0	
	8200	2877	1626	3.75	1750	5.13	1862	6.53	1966	7.96	2171	11.1	2362	14.3	2551	17.9	2735	21.7	2915	25.8	
	9500	3333	1842	5.27	1956	6.87	2059	8.50	2152	10.1	2337	13.5	2511	17.1	2678	20.9	2843	24.9	3000	29.0	
	10800	3789	2062	7.21	2168	9.05	2261	10.8	2349	12.7	2515	16.4	2671	20.2	2827	24.4	2978	28.7	3127	33.3	
	12100	4246	2284	9.60	2383	11.7	2471	13.7	2554	15.8	2705	19.8	2852	24.1	2990	28.4	3126	32.9			

Performance certified is for installation Type B: Free inlet, Ducted outlet. Power rating (BHP) does not include transmission losses. Performance ratings do not include the effects of appurtenances (accessories).

PERFORMANCE FOR SINGLE-WIDTH FANS WITH **ACOUSTAFOIL** WHEELS

SIZE 24 Max. safe speeds Class 1=1790 RPM Class 2=2335 RPM Class 3=2940 RPM	CFM	OV	1"SP		2"SP		3"SP		4"SP		6"SP		8"SP		10"SP		12"SP		14"SP	
			RPM	BHP	RPM	BHP	RPM	BHP	RPM	BHP	RPM	BHP	RPM	BHP	RPM	BHP	RPM	BHP	RPM	BHP
	3000	870	728	0.84	996	1.49	1223	2.29	1419	3.29	1747	5.64	2023	8.32	2272	11.4	2494	14.6	2690	18.0
	5000	1449	904	1.30	1080	2.09	1254	3.08	1421	4.26	1725	6.89	1997	9.94	2241	13.3	2459	16.8	2670	20.8
	7000	2029	1137	2.06	1269	3.14	1397	4.38	1522	5.69	1770	8.64	2007	11.9	2233	15.6	2443	19.5	2637	23.5
	9000	2609	1386	3.30	1499	4.75	1602	6.23	1703	7.78	1898	11.0	2093	14.7	2281	18.5	2468	22.7	2644	27.0
	11000	3188	1642	5.12	1743	6.92	1832	8.68	1917	10.5	2083	14.2	2242	18.2	2400	22.3	2563	26.9	2722	31.7
	13000	3768	1903	7.57	1995	9.75	2076	11.8	2151	13.9	2296	18.2	2434	22.6	2571	27.2	2706	32.0	2845	37.2
	15000	4348	2167	10.8	2250	13.3	2327	15.8	2395	18.2	2523	23.0	2649	28.0	2769	33.0	2886	38.1		
	17000	4928	2433	14.9	2510	17.8	2581	20.6	2645	23.4	2764	28.8	2879	34.4						

SIZE 27 Max. safe speeds Class 1=1540 RPM Class 2=2010 RPM Class 3=2530 RPM	CFM	OV	1"SP		2"SP		3"SP		4"SP		6"SP		8"SP		10"SP		12"SP		14"SP	
			RPM	BHP	RPM	BHP	RPM	BHP	RPM	BHP	RPM	BHP	RPM	BHP	RPM	BHP	RPM	BHP	RPM	BHP
	4000	955	657	0.78	900	1.70	1107	2.83	1289	4.14	1583	7.03	1837	10.4	2051	14.0	2258	18.1	2441	22.4
	7000	1671	841	1.62	992	2.78	1139	4.08	1290	5.60	1563	8.94	1809	12.8	2024	16.9	2232	21.6	2411	26.3
	9000	2148	1001	2.53	1122	3.93	1239	5.43	1355	7.04	1586	10.6	1805	14.7	2015	19.1	2211	24.0	2394	29.1
	11000	2625	1173	3.82	1276	5.48	1371	7.16	1468	8.99	1659	12.9	1849	17.2	2030	21.8	2213	26.9	2388	32.4
	13000	3103	1350	5.54	1440	7.49	1524	9.44	1605	11.4	1769	15.8	1932	20.5	2091	25.3	2252	30.7	2405	36.2
	15000	3580	1530	7.77	1611	10.0	1686	12.3	1759	14.5	1899	19.2	2041	24.2	2182	29.6	2321	35.1	2461	41.0
	17000	4057	1713	10.6	1786	13.1	1856	15.7	1920	18.2	2045	23.3	2172	28.8	2296	34.5	2421	40.5		
	19000	4535	1897	14.1	1964	16.9	2028	19.8	2088	22.6	2203	28.2	2315	34.1	2427	40.2				

SIZE 30 Max. safe speeds Class 1=1385 RPM Class 2=1805 RPM Class 3=2275 RPM	CFM	OV	1"SP		2"SP		3"SP		4"SP		6"SP		8"SP		10"SP		12"SP		14"SP	
			RPM	BHP	RPM	BHP	RPM	BHP	RPM	BHP	RPM	BHP	RPM	BHP	RPM	BHP	RPM	BHP	RPM	BHP
	7000	1354	670	1.44	836	2.73	1000	4.29	1150	6.03	1416	10.0	1643	14.5	1840	19.3	2015	24.4	2182	30.1
	9000	1741	776	2.13	907	3.60	1036	5.25	1165	7.13	1408	11.4	1628	16.2	1824	21.4	2005	27.1	2172	33.1
	11000	2128	895	3.08	1002	4.74	1109	6.58	1215	8.58	1428	13.1	1632	18.3	1820	23.8	1995	29.8	2155	35.9
	13000	2515	1020	4.32	1114	6.25	1203	8.25	1293	10.4	1475	15.2	1650	20.5	1824	26.3	1994	32.7	2148	39.2
	15000	2901	1148	5.91	1232	8.12	1311	10.3	1391	12.8	1548	17.9	1700	23.3	1858	29.5	2011	36.1	2155	42.8
	17000	3288	1277	7.86	1355	10.4	1426	12.9	1496	15.4	1636	21.0	1771	26.8	1912	33.3	2045	39.8	2184	47.2
	19000	3675	1409	10.3	1481	13.1	1547	15.9	1611	18.7	1735	24.6	1858	30.9	1979	37.3	2101	44.3	2228	52.0
	21000	4062	1542	13.2	1608	16.3	1671	19.4	1729	22.5	1841	28.7	1956	35.5	2068	42.5	2175	49.6		

SIZE 33 Max. safe speeds Class 1=1265 RPM Class 2=1650 RPM Class 3=2080 RPM	CFM	OV	1"SP		2"SP		3"SP		4"SP		6"SP		8"SP		10"SP		12"SP		14"SP	
			RPM	BHP	RPM	BHP	RPM	BHP	RPM	BHP	RPM	BHP	RPM	BHP	RPM	BHP	RPM	BHP	RPM	BHP
	7000	1118	563	1.38	747	2.87	905	4.62	1043	6.55	1276	10.8	1483	15.8	1662	21.2	1832	27.3	1983	33.5
	10000	1597	654	2.13	800	3.96	936	6.00	1060	8.23	1280	13.1	1473	18.6	1650	24.6	1808	30.9	1960	37.9
	13000	2077	780	3.33	886	5.38	997	7.73	1106	10.3	1305	15.8	1487	21.8	1651	28.3	1805	35.3	1953	42.8
	16000	2556	924	5.14	1000	7.35	1086	9.90	1176	12.7	1355	19.0	1524	25.7	1678	32.8	1827	40.5	1959	48.1
	19000	3035	1073	7.63	1132	10.0	1199	12.8	1274	15.9	1424	22.6	1573	29.8	1719	37.7	1855	45.9	1990	54.7
	21000	3355	1175	9.77	1226	12.3	1284	15.2	1348	18.4	1483	25.4	1621	33.2	1757	41.4	1887	50.1	2009	58.8
	24000	3834	1329	13.7	1374	16.6	1420	19.6	1472	23.0	1586	30.5	1704	38.6	1826	47.5	1949	57.0	2063	66.5
	27000	4313	1484	18.7	1524	21.9	1564	25.2	1606	28.7	1702	36.6	1806	45.2	1911	54.5	2021	64.6		

SIZE 36 Max. safe speeds Class 1=1110 RPM Class 2=1450 RPM Class 3=1825 RPM	CFM	OV	1"SP		2"SP		3"SP		4"SP		6"SP		8"SP		10"SP		12"SP		14"SP	
			RPM	BHP	RPM	BHP	RPM	BHP	RPM	BHP	RPM	BHP	RPM	BHP	RPM	BHP	RPM	BHP	RPM	BHP
	10000	1305	539	1.97	683	3.83	819	6.02	943	8.48	1162	14.1	1348	20.3	1508	26.8	1656	34.0	1790	41.6
	14000	1828	656	3.30	760	5.51	864	8.03	966	10.8	1158	17.0	1337	24.0	1496	31.4	1642	39.4	1777	47.9
	18000	2350	788	5.29	871	7.93	952	10.8	1033	13.9	1193	20.7	1350	28.3	1496	36.5	1637	45.3	1767	54.5
	22000	2872	926	8.07	999	11.3	1066	14.5	1133	18.0	1264	25.4	1393	33.4	1523	42.3	1648	51.6	1776	62.0
	26000	3394	1068	11.8	1133	15.6	1192	19.4	1250	23.3	1361	31.4	1472	40.1	1582	49.4	1695	59.7	1805	70.3
	30000	3916	1212	16.7	1271	21.1	1325	25.4	1375	29.7	1475	38.8	1570	48.1	1670	58.6	1767	69.2		
	34000	4439	1358	22.9	1412	27.9	1462	32.8	1508	37.7	1598	47.8	1683	57.9	1770	68.9				
	38000	4961	1505	30.6	1555	36.1	1601	41.7	1644	47.1	1727	58.3	1806	69.5						

SIZE 40 Max. safe speeds Class 1=1005 RPM Class 2=1315 RPM Class 3=1655 RPM	CFM	OV	1"SP		2"SP		3"SP		4"SP		6"SP		8"SP		10"SP		12"SP		14"SP	
			RPM	BHP	RPM	BHP	RPM	BHP	RPM	BHP	RPM	BHP	RPM	BHP	RPM	BHP	RPM	BHP	RPM	BHP
	12000	1289	487	2.36	618	4.59	742	7.27	857	10.3	1055	17.1	1219	24.5	1369	32.8	1500	41.3	1624	50.6
	16000	1719	571	3.63	671	6.19	770	9.10	869	12.5	1051	19.9	1215	28.4	1357	37.2	1491	46.9	1613	57.0
	20000	2148	667	5.43	749	8.43	828	11.7	909	15.2	1066	23.2	1217	32.3	1353	41.9	1482	52.3	1606	63.6
	24000	2578	769	7.82	839	11.3	907	15.0	973	18.9	1105	27.3	1238	36.9	1364	47.2	1485	58.2	1604	70.3
	28000	3008	873	10.9	936	15.0	994	19.1	1053	23.5	1167	32.6	1279	42.4	1395	53.5	1504	65.0	1616	77.9
	32000	3437	980	14.7	1037	19.6	1090	24.3	1141	29.0	1241	38.8	1342	49.6	1443	61.1	1538	72.7	1638	85.7
	36000	3867	1089	19.5	1141	25.0	1189	30.4	1236	35.7	1325	46.4	1416	57.9	1505	69.9	1595	82.7		
	40000	4296	1198	25.3	1246	31.5	1290	37.4	1334	43.4	1415	55.0	1496	67.2	1577	80.0				

Performance certified is for installation Type B: Free inlet, Ducted outlet. Power rating (BHP) does not include transmission losses. Performance ratings do not include the effects of aperturancs (accessories).

PERFORMANCE FOR SINGLE-WIDTH FANS WITH **ACOUSTAFoil** WHEELS

SIZE 44	CFM	OV	1"SP		2"SP		3"SP		4"SP		6"SP		8"SP		10"SP		12"SP		14"SP	
			RPM	BHP	RPM	BHP	RPM	BHP	RPM	BHP	RPM	BHP	RPM	BHP	RPM	BHP	RPM	BHP	RPM	BHP
Max. safe speeds Class 1= 910 RPM Class 2=1190 RPM Class 3=1495 RPM	14000	1229	431	2.71	556	5.42	672	8.67	775	12.3	954	20.4	1104	29.4	1241	39.4	1361	49.8	1466	60.4
	20000	1756	523	4.60	613	7.79	700	11.4	787	15.4	952	24.8	1094	34.8	1231	46.4	1351	58.3	1460	70.6
	25000	2195	613	6.93	686	10.6	758	14.7	829	19.1	968	28.9	1099	39.8	1224	51.9	1339	64.6	1449	78.3
	30000	2634	708	10.0	770	14.4	830	19.0	889	23.7	1005	34.1	1122	45.8	1235	58.5	1344	72.1	1450	86.9
	35000	3073	805	14.0	861	19.2	913	24.3	964	29.6	1066	41.1	1166	53.2	1267	66.8	1367	81.2	1463	96.4
	40000	3512	904	19.0	955	25.1	1002	30.9	1047	36.8	1136	49.0	1226	62.4	1314	76.4	1401	91.1	1487	107
	45000	3951	1005	25.2	1050	32.0	1094	38.7	1135	45.3	1216	58.9	1294	72.8	1373	87.7	1451	103		
50000	4390	1106	32.7	1149	40.5	1189	48.1	1227	55.5	1299	69.9	1372	85.2	1443	101					

SIZE 49	CFM	OV	1"SP		2"SP		3"SP		4"SP		6"SP		8"SP		10"SP		12"SP		14"SP	
			RPM	BHP	RPM	BHP	RPM	BHP	RPM	BHP	RPM	BHP	RPM	BHP	RPM	BHP	RPM	BHP	RPM	BHP
Max. safe speeds Class 1= 850 RPM Class 2=1105 RPM Class 3=1395 RPM	17000	1232	392	3.30	505	6.57	611	10.5	705	15.0	865	24.7	1002	35.5	1126	47.6	1235	60.4	1332	73.2
	24000	1739	472	5.46	554	9.34	635	13.7	715	18.7	862	29.7	998	42.4	1115	55.5	1226	70.1	1326	85.2
	30000	2174	553	8.23	619	12.7	684	17.5	749	22.9	875	34.5	1000	48.2	1113	62.7	1220	78.4	1316	94.3
	36000	2609	638	11.9	695	17.2	749	22.6	803	28.3	913	41.2	1019	55.2	1121	70.4	1222	87.2	1316	104
	42000	3043	725	16.6	776	22.8	823	28.9	871	35.5	962	48.9	1054	63.6	1148	80.2	1237	97.1	1326	116
	48000	3478	814	22.5	860	29.7	903	36.8	945	43.9	1027	58.7	1107	74.5	1190	91.6	1270	110	1350	129
	54000	3913	904	29.7	946	38.1	985	46.0	1023	54.0	1096	70.0	1169	86.9	1242	105	1315	124	1385	144
60000	4348	995	38.6	1034	47.9	1071	57.1	1105	65.8	1173	83.6	1238	102	1304	121	1369	141			

SIZE 54	CFM	OV	1"SP		2"SP		3"SP		4"SP		6"SP		8"SP		10"SP		12"SP		14"SP		
			RPM	BHP	RPM	BHP	RPM	BHP	RPM	BHP	RPM	BHP	RPM	BHP	RPM	BHP	RPM	BHP	RPM	BHP	RPM
Max. safe speeds Class 1= 750 RPM Class 2= 975 RPM Class 3=1230 RPM	20000	1182	349	3.86	454	7.81	552	12.6	636	17.8	783	29.7	908	43.0	1019	57.6	1114	72.3	1205	88.6	
	30000	1773	432	6.95	504	11.7	575	17.1	647	23.2	779	36.8	900	52.3	1009	69.1	1108	87.0	1198	105	
	40000	2364	532	11.9	588	17.8	642	24.0	697	30.8	804	45.8	908	62.5	1005	80.6	1099	100	1189	121	
	50000	2955	639	19.1	686	26.4	730	33.8	774	41.6	860	58.0	945	75.8	1030	95.4	1112	116	1196	139	
	60000	3546	748	28.8	789	37.9	827	46.7	864	55.5	937	74.1	1009	93.6	1081	115	1154	137	1223	160	
	65000	3842	803	34.8	842	44.9	879	54.6	913	64.0	980	83.6	1047	104	1112	125	1179	149			
	70000	4137	859	41.8	896	52.7	930	63.2	962	73.3	1026	94.2	1088	116	1149	138	1212	162			
75000	4433	915	49.7	949	61.3	982	72.7	1013	83.7	1073	106	1131	129	1190	152						

SIZE 60	CFM	OV	1"SP		2"SP		3"SP		4"SP		6"SP		8"SP		10"SP		12"SP		14"SP		
			RPM	BHP	RPM	BHP	RPM	BHP	RPM	BHP	RPM	BHP	RPM	BHP	RPM	BHP	RPM	BHP	RPM	BHP	RPM
Max. safe speeds Class 1= 675 RPM Class 2= 880 RPM Class 3=1110 RPM	25000	1208	318	4.85	411	9.68	497	15.5	574	22.0	707	36.8	821	53.1	918	70.6	1011	90.2	1092	110	
	35000	1691	379	7.84	447	13.5	514	19.9	581	27.3	703	43.7	815	62.6	910	81.9	1002	104	1085	126	
	45000	2174	451	12.3	506	19.1	559	26.3	611	34.2	715	51.9	816	72.2	909	94.1	994	117	1079	143	
	55000	2657	529	18.5	574	26.5	618	34.8	661	43.5	749	62.8	836	84.4	916	107	999	132	1076	159	
	65000	3140	608	26.7	649	36.4	687	45.9	724	55.7	798	76.7	870	98.8	945	124	1017	150	1086	177	
	75000	3623	689	37.1	726	48.6	760	59.6	793	70.7	856	93.2	922	118	985	144	1048	171			
	85000	4106	772	50.3	805	63.3	836	76.1	865	88.3	922	113	979	140	1035	167	1093	197			
95000	4589	854	66.4	885	81.3	914	95.8	941	110	993	138	1044	166	1095	196						

SIZE 66	CFM	OV	1"SP		2"SP		3"SP		4"SP		6"SP		8"SP		10"SP		12"SP		14"SP	
			RPM	BHP	RPM	BHP	RPM	BHP	RPM	BHP	RPM	BHP	RPM	BHP	RPM	BHP	RPM	BHP	RPM	BHP
Max. safe speeds Class 1= 615 RPM Class 2= 800 RPM Class 3=1010 RPM	30000	1198	288	5.81	374	11.7	453	18.8	523	26.7	643	44.3	745	63.9	835	85.1	916	108	990	132
	42000	1677	343	9.39	405	16.2	468	24.1	529	33.0	639	52.5	738	74.6	830	99.3	912	125	985	152
	54000	2156	408	14.7	457	22.7	507	31.6	555	41.1	651	62.7	741	86.9	828	114	906	142	980	171
	66000	2635	477	22.0	519	31.7	559	41.5	600	52.4	679	75.2	759	101	833	129	909	160	977	191
	78000	3114	549	31.7	586	43.4	621	54.7	655	66.5	723	91.8	789	119	855	148	922	180	985	213
	90000	3593	622	44.0	655	57.6	687	71.1	717	84.4	775	112	833	141	894	173	950	205	1007	239
	102000	4072	696	59.6	727	75.4	755	90.7	782	105	835	136	887	167	939	201	990	235		
114000	4551	771	78.8	799	96.5	825	114	850	131	898	164	945	198	991	234					

SIZE 73	CFM	OV	1"SP		2"SP		3"SP		4"SP		6"SP		8"SP		10"SP		12"SP		14"SP		
			RPM	BHP	RPM	BHP	RPM	BHP	RPM	BHP	RPM	BHP	RPM	BHP	RPM	BHP	RPM	BHP	RPM	BHP	RPM
Max. safe speeds Class 1= 555 RPM Class 2= 725 RPM Class 3= 915 RPM	40000	1305	270	7.89	341	15.3	409	24.1	474	34.4	580	56.5	671	80.9	755	109	828	137	893	166	
	55000	1795	324	12.8	377	21.5	429	31.2	481	42.2	580	67.4	670	95.7	750	126	824	159	890	192	
	70000	2285	386	20.2	428	30.5	470	41.7	512	53.7	594	80.6	672	110	748	144	818	178	884	216	
	85000	2774	450	30.0	487	42.6	522	55.3	555	68.4	624	97.4	693	130	757	164	823	202	887	243	
	100000	3264	517	43.1	549	58.2	579	72.7	609	87.9	668	120	725	153	784	191	840	229	896	270	
	115000	3753	585	59.7	614	77.1	641	94.3	667	111	719	146	768	182	820	222	870	263			
	130000	4243	653	80.7	680	101	705	120	728	139	775	178	819	217	864	259	910	303			
145000	4732	723	107	747	129	770	151	792	173	834	215	875	258								

Performance certified is for installation Type B: Free inlet, Ducted outlet. Power rating (BHP) does not include transmission losses.
 Performance ratings do not include the effects of appurtenances (accessories).

PERFORMANCE FOR SINGLE-WIDTH FANS WITH **BC** WHEELS

SIZE 18 Max. safe speeds Class 1=2100 RPM Class 2=2735 RPM	CFM	OV	1"SP		2"SP		3"SP		4"SP		5"SP		6"SP		7"SP		8"SP		10"SP	
			RPM	BHP	RPM	BHP	RPM	BHP	RPM	BHP	RPM	BHP	RPM	BHP	RPM	BHP	RPM	BHP	RPM	BHP
			2000	1042	924	0.69	1223	1.14	1473	1.64	1691	2.19	1893	2.85	2070	3.58	2238	4.37	2400	5.23
2900	1510	1089	0.96	1320	1.46	1531	2.03	1731	2.72	1914	3.51	2088	4.37	2245	5.24	2394	6.16	2672	8.11	
3800	1979	1296	1.38	1479	1.97	1658	2.63	1822	3.41	1982	4.29	2140	5.26	2295	6.30	2430	7.30	2693	9.45	
4700	2448	1523	1.97	1675	2.70	1818	3.52	1967	4.42	2103	5.34	2237	6.33	2371	7.42	2500	8.56			
5600	2917	1761	2.83	1887	3.74	2016	4.72	2135	5.69	2261	6.75	2382	7.83	2496	8.92	2608	10.1			
6500	3385	2006	4.07	2116	5.12	2225	6.19	2334	7.32	2438	8.45	2542	9.62	2651	10.9					
7400	3854	2255	5.67	2351	6.83	2447	8.04	2546	9.31	2639	10.5	2730	11.8							
8300	4323	2507	7.67	2592	8.95	2677	10.3													

SIZE 22 Max. safe speeds Class 1=1770 RPM Class 2=2305 RPM	CFM	OV	1"SP		2"SP		3"SP		4"SP		5"SP		6"SP		7"SP		8"SP		10"SP	
			RPM	BHP	RPM	BHP	RPM	BHP	RPM	BHP	RPM	BHP	RPM	BHP	RPM	BHP	RPM	BHP	RPM	BHP
			3000	1053	768	0.87	1000	1.48	1214	2.22	1390	3.07	1552	4.10	1694	5.17	1827	6.33	1956	7.60
4300	1509	915	1.27	1093	1.94	1262	2.80	1417	3.84	1572	5.00	1715	6.21	1845	7.45	1967	8.77	2196	11.7	
5600	1965	1085	1.84	1234	2.72	1373	3.73	1504	4.82	1630	6.04	1752	7.38	1874	8.83	1993	10.3	2212	13.4	
6900	2421	1271	2.67	1399	3.88	1516	5.03	1628	6.24	1741	7.57	1848	8.94	1947	10.3	2051	12.0	2248	15.4	
8200	2877	1468	3.97	1573	5.30	1680	6.75	1780	8.13	1876	9.55	1970	11.0	2060	12.5	2153	14.2			
9500	3333	1671	5.67	1759	7.14	1854	8.80	1946	10.5	2033	12.1	2115	13.7	2195	15.3	2277	17.1			
10800	3789	1876	7.79	1955	9.53	2033	11.2	2117	13.2	2199	15.1	2275	16.9							
12100	4246	2083	10.4	2154	12.4	2224	14.3	2295	16.3											

SIZE 24 Max. safe speeds Class 1=1605 RPM Class 2=2090 RPM	CFM	OV	1"SP		2"SP		3"SP		4"SP		5"SP		6"SP		7"SP		8"SP		10"SP	
			RPM	BHP	RPM	BHP	RPM	BHP	RPM	BHP	RPM	BHP	RPM	BHP	RPM	BHP	RPM	BHP	RPM	BHP
			3000	870	660	0.87	899	1.57	1091	2.38	1255	3.41	1402	4.59	1534	5.86	1774	8.72	1980	11.8
5000	1449	812	1.40	979	2.20	1135	3.28	1283	4.54	1427	5.93	1551	7.29	1785	10.4	1984	13.7	1984	13.7	
7000	2029	1008	2.29	1140	3.46	1261	4.69	1378	6.02	1492	7.52	1602	9.18	1813	12.8	2016	16.6	2016	16.6	
9000	2609	1226	3.83	1332	5.34	1435	6.88	1532	8.42	1627	10.1	1718	11.8	1899	15.5	2066	19.7	2066	19.7	
11000	3188	1456	6.14	1542	7.87	1630	9.79	1716	11.7	1798	13.6	1876	15.5	2026	19.4					
13000	3768	1692	9.29	1763	11.3	1836	13.4	1913	15.8	1987	18.0	2059	20.3							
15000	4348	1931	13.4	1994	15.9	2056	18.2													
17000	4928																			

SIZE 27 Max. safe speeds Class 1=1420 RPM Class 2=1850 RPM	CFM	OV	1"SP		2"SP		3"SP		4"SP		5"SP		6"SP		7"SP		8"SP		10"SP	
			RPM	BHP	RPM	BHP	RPM	BHP	RPM	BHP	RPM	BHP	RPM	BHP	RPM	BHP	RPM	BHP	RPM	BHP
			4000	955	627	0.87	827	1.83	1003	3.03	1158	4.40	1292	5.86	1418	7.52	1531	9.25	1636	11.1
7000	1671	819	1.87	968	3.20	1089	4.56	1210	6.11	1326	7.8	1433	9.56	1539	11.5	1641	13.6	1835	18.2	
9000	2148	972	2.92	1094	4.55	1211	6.27	1311	7.96	1407	9.82	1501	11.8	1587	13.7	1678	15.9			
11000	2625	1136	4.44	1239	6.29	1339	8.35	1437	10.5	1524	12.5	1606	14.6	1683	16.8	1758	19.1			
13000	3103	1305	6.50	1396	8.61	1480	10.8	1568	13.3	1651	15.8	1729	18.2	1802	20.6					
15000	3580	1477	9.17	1561	11.6	1637	14.1	1709	16.7	1785	19.5									
17000	4057	1652	12.6	1728	15.3	1799	18.1													
19000	4535	1829	16.8																	

SIZE 30 Max. safe speeds Class 1=1280 RPM Class 2=1665 RPM	CFM	OV	1"SP		2"SP		3"SP		4"SP		5"SP		6"SP		7"SP		8"SP		10"SP	
			RPM	BHP	RPM	BHP	RPM	BHP	RPM	BHP	RPM	BHP	RPM	BHP	RPM	BHP	RPM	BHP	RPM	BHP
			7000	1354	656	1.68	800	3.05	930	4.62	1053	6.41	1170	8.43	1278	10.6	1378	12.9	1471	15.3
9000	1741	756	2.46	887	4.17	997	5.92	1098	7.80	1200	9.93	1299	12.2	1393	14.7	1483	17.3	1653	22.9	
11000	2128	868	3.54	980	5.55	1085	7.64	1176	9.75	1262	12	1344	14.3	1428	16.8	1507	19.5			
13000	2515	987	4.99	1083	7.20	1177	9.66	1268	12.2	1345	14.6	1421	17.2	1490	19.7	1560	22.5			
15000	2901	1109	6.85	1195	9.31	1277	12.0	1358	14.8	1436	17.7	1509	20.5	1577	23.5	1639	26.4			
17000	3288	1234	9.19	1313	12.0	1386	14.8	1458	17.9	1531	21.2	1599	24.3	1664	27.5					
19000	3675	1360	12.0	1434	15.2	1501	18.3	1566	21.6	1630	25									
21000	4062	1487	15.5	1557	19.0	1620	22.4													

SIZE 33 Max. safe speeds Class 1=1175 RPM Class 2=1515 RPM	CFM	OV	1"SP		2"SP		3"SP		4"SP		5"SP		6"SP		7"SP		8"SP		10"SP	
			RPM	BHP	RPM	BHP	RPM	BHP	RPM	BHP	RPM	BHP	RPM	BHP	RPM	BHP	RPM	BHP	RPM	BHP
			7000	1118	546	1.56	690	3.06	826	4.90	947	6.99	1062	9.4	1157	11.8	1254	14.6	1341	17.4
10000	1597	652	2.60	775	4.47	879	6.50	982	8.82	1079	11.3	1172	14.0	1261	16.9	1344	20.0	1500	26.6	
13000	2077	776	4.08	879	6.45	976	8.90	1060	11.5	1140	14.2	1216	17.0	1295	20.1	1370	23.3	1512	30.2	
16000	2556	910	6.27	996	8.98	1081	12.0	1159	14.9	1233	18	1300	21.1	1363	24.3	1427	27.8			
19000	3035	1048	9.22	1123	12.3	1194	15.6	1266	19.2	1335	22.7	1401	26.3	1461	29.9					
21000	3355	1142	11.7	1214	15.1	1278	18.6	1343	22.4	1408	26.5	1470	30.4							
24000	3834	1284	16.2	1350	20.2	1409	24.1	1465	28.1											
27000	4313	1429	22.0	1488	26.3															

Performance certified is for installation Type B: Free inlet, Ducted outlet. Power rating (BHP) does not include transmission losses. Performance ratings do not include the effects of aperturancas (accessories).

PERFORMANCE FOR SINGLE-WIDTH FANS WITH **BC** WHEELS

SIZE 36	CFM	OV	1"SP		2"SP		3"SP		4"SP		5"SP		6"SP		7"SP		8"SP		9"SP	
			RPM	BHP	RPM	BHP	RPM	BHP	RPM	BHP	RPM	BHP	RPM	BHP	RPM	BHP	RPM	BHP	RPM	BHP
			Max. safe speeds Class 1=1045 RPM Class 2=1360 RPM																	
10000	1305	512	2.22	648	4.19	770	6.62	878	9.37	973	12.2	1066	15.5	1146	18.7	1226	22.2	1302	26	
14000	1828	618	3.74	721	6.21	820	8.86	914	11.8	1004	15.1	1088	18.6	1163	22.2	1238	26.2	1311	30.4	
18000	2350	741	6.05	823	9.00	902	12.1	982	15.5	1058	19	1131	22.6	1203	26.5	1271	30.7	1339	35.2	
22000	2872	872	9.42	940	12.8	1006	16.5	1072	20.3	1136	24.2	1199	28.3	1262	32.5	1325	37.0			
26000	3394	1007	14.0	1066	17.9	1121	22.0	1178	26.3	1234	30.8	1291	35.6	1345	40.3					
30000	3916	1144	20.1	1196	24.5	1245	29.0	1295	33.8	1345	38.9									
34000	4439	1284	27.8	1330	32.8															
38000	4961																			

SIZE 40	CFM	OV	1"SP		2"SP		3"SP		4"SP		5"SP		6"SP		7"SP		8"SP		9"SP	
			RPM	BHP	RPM	BHP	RPM	BHP	RPM	BHP	RPM	BHP	RPM	BHP	RPM	BHP	RPM	BHP	RPM	BHP
			Max. safe speeds Class 1= 950 RPM Class 2=1235 RPM																	
12000	1289	463	2.58	585	5.03	696	7.93	796	11.1	888	14.6	972	18.3	1047	22	1120	26.0	1192	30.4	
16000	1719	541	4.03	639	6.77	733	10.0	818	13.6	901	17.5	978	21.5	1051	25.7	1120	30.1	1186	34.8	
20000	2148	627	5.99	714	9.37	789	12.8	865	16.7	937	20.9	1008	25.5	1072	30	1136	34.9	1198	39.9	
24000	2578	721	8.75	793	12.5	865	16.7	927	20.7	988	25	1052	30.0	1112	35	1171	40.4	1229	46	
28000	3008	820	12.4	880	16.6	943	21.3	1002	26.0	1057	30.6	1113	35.7	1165	40.9	1219	46.7			
32000	3437	921	17.1	974	21.9	1026	26.8	1081	32.2	1136	37.7	1185	43.1	1230	48.2					
36000	3867	1023	22.9	1071	28.3	1117	33.7	1164	39.3	1215	45.6									
40000	4296	1126	30.0	1170	35.9	1212	41.9													

SIZE 44	CFM	OV	1"SP		2"SP		3"SP		4"SP		5"SP		6"SP		7"SP		8"SP		9"SP	
			RPM	BHP	RPM	BHP	RPM	BHP	RPM	BHP	RPM	BHP	RPM	BHP	RPM	BHP	RPM	BHP	RPM	BHP
			Max. safe speeds Class 1= 880 RPM Class 2=1120 RPM																	
14000	1229	411	2.98	526	5.96	626	9.37	718	13.2	802	17.4	877	21.7	949	26.4	1016	31.3	1077	36.3	
20000	1756	495	5.09	583	8.51	666	12.5	742	16.9	817	21.7	886	26.7	951	31.8	1017	37.6	1076	43.3	
25000	2195	576	7.65	654	11.9	721	16.1	788	20.9	853	26.1	914	31.6	975	37.5	1032	43.5	1088	49.8	
30000	2634	665	11.3	728	16.0	791	21.1	848	26.1	904	31.6	960	37.6	1014	43.9	1064	50.3	1116	57.2	
35000	3073	756	16.0	809	21.2	863	26.9	918	32.9	968	38.8	1014	44.7	1061	51.2	1110	58.4			
40000	3512	849	22.0	896	28.0	942	34.1	991	40.7	1041	47.9	1083	54.3							
45000	3951	944	29.6	987	36.3	1028	43.1	1068	49.9	1112	57.5									
50000	4390	1039	38.9	1078	46.2	1116	53.8													

SIZE 49	CFM	OV	1"SP		2"SP		3"SP		4"SP		5"SP		6"SP		7"SP		8"SP		9"SP	
			RPM	BHP	RPM	BHP	RPM	BHP	RPM	BHP	RPM	BHP	RPM	BHP	RPM	BHP	RPM	BHP	RPM	BHP
			Max. safe speeds Class 1= 780 RPM Class 2=1020 RPM																	
17000	1232	373	3.59	477	7.20	568	11.3	652	16.0	728	21.0	796	26.2	861	32.0	925	38.3	978	44.0	
24000	1739	447	6.07	527	10.2	603	15.0	674	20.3	740	26.0	803	32.0	863	38.4	924	45.4	979	52.5	
30000	2174	520	9.12	590	14.1	651	19.1	714	25.1	772	31.3	828	37.9	884	45.1	937	52.5	985	59.6	
36000	2609	599	13.4	655	18.9	714	25.1	766	31.2	817	37.8	868	45.1	918	52.8	965	60.5	1013	69.0	
42000	3043	681	18.9	729	25.2	780	32.2	830	39.5	875	46.4	917	53.4	961	61.4	1006	70.1			
48000	3478	764	26.0	808	33.3	850	40.7	896	48.8	940	57.1	979	65.0	1017	73.0					
54000	3913	849	35.0	888	43.0	926	51.2	963	59.4	1003	68.5									
60000	4348	935	45.9	971	54.7	1006	63.9													

SIZE 54	CFM	OV	1"SP		2"SP		3"SP		4"SP		5"SP		6"SP		7"SP		8"SP		9"SP	
			RPM	BHP	RPM	BHP	RPM	BHP	RPM	BHP	RPM	BHP	RPM	BHP	RPM	BHP	RPM	BHP	RPM	BHP
			Max. safe speeds Class 1= 710 RPM Class 2= 920 RPM																	
20000	1182	331	4.19	427	8.54	513	13.6	587	19.1	658	25.3	720	31.6	779	38.6	835	45.9	888	53.7	
30000	1773	409	7.68	480	12.8	548	18.7	611	25.3	670	32.3	726	39.8	783	48.0	834	56.2	883	64.7	
40000	2364	500	13.3	558	19.8	613	26.5	662	33.5	715	41.8	764	50.3	809	59.0	854	68.2	898	77.7	
50000	2955	600	21.7	645	29.3	693	37.7	737	46.0	777	54.2	818	63.1	861	73.3	900	83.4			
60000	3546	703	33.5	741	42.4	778	51.7	818	61.7	857	71.8	893	81.8							
65000	3842	755	40.9	790	50.6	825	60.4	861	70.8	898	81.9									
70000	4137	807	49.5	841	59.7	873	70.2	905	80.9											
75000	4433	860	59.3	892	70.2															

SIZE 60	CFM	OV	1"SP		2"SP		3"SP		4"SP		5"SP		6"SP		7"SP		8"SP		9"SP	
			RPM	BHP	RPM	BHP	RPM	BHP	RPM	BHP	RPM	BHP	RPM	BHP	RPM	BHP	RPM	BHP	RPM	BHP
			Max. safe speeds Class 1= 640 RPM Class 2= 830 RPM																	
25000	1208	302	5.27	387	10.6	464	16.8	532	23.7	594	31.2	652	39.2	704	47.7	753	56.4	800	65.8	
35000	1691	360	8.72	426	14.8	490	22.0	547	29.8	603	38.3	657	47.5	705	56.7	753	66.8	796	76.6	
45000	2174	425	13.7	482	21.2	533	28.9	582	37.4	631	47.1	676	56.8	722	67.7	763	78.1	806	89.8	
55000	2657	496	20.8	543	29.5	590	39.0	630	47.8	671	57.7	713	68.9	752	80.1	790	91.9	830	105	
65000	3140	571	30.5	609	40.2	649	50.8	689	62.0	726	73.0	759	83.7	794	95.4	829	108			
75000	3623	647	43.2	682	54.5	714	65.8	750	78.2	785	91.2	818	104							
85000	4106	725	59.4	755	71.9	785	84.7	814	97.8											
95000	4589	803	79.5																	

Performance certified is for installation Type B: Free inlet, Ducted outlet. Power rating (BHP) does not include transmission losses. Performance ratings do not include the effects of appurtenances (accessories).

PERFORMANCE FOR SINGLE-WIDTH FANS WITH WHEELS

SIZE 66	CFM	OV	1"SP		2"SP		3"SP		4"SP		5"SP		6"SP		7"SP		8"SP		9"SP				
			RPM	BHP	RPM	BHP	RPM	BHP	RPM	BHP	RPM	BHP	RPM	BHP	RPM	BHP	RPM	BHP	RPM	BHP	RPM	BHP	
Max. safe speeds Class 1= 585 RPM Class 2= 755 RPM	30000	1198	274	6.31	352	12.7	422	20.3	485	28.7	541	37.7	594	47.5	640	57.5	685	68.2	726	79.0			
	42000	1677	325	10.4	386	17.7	445	26.5	497	35.9	549	46.3	596	57.0	640	68.1	684	80.4	724	92.4			
	54000	2156	383	16.2	436	25.3	482	34.3	528	45.0	574	56.8	615	68.6	655	81.2	693	93.9	732	108			
	66000	2635	448	24.7	490	35.0	533	46.4	572	57.4	609	69.4	646	82.4	684	96.8	719	111	753	126			
	78000	3114	516	36.3	551	48.0	588	60.8	624	74.1	657	87.1	687	100	721	115	751	130					
	90000	3593	584	51.3	615	64.7	645	78.2	677	93.1	710	109	740	124									
	102000	4072	654	70.3	682	85.3	709	101	736	116													
	114000	4551	724	94.1	750	111																	

PERFORMANCE FOR SINGLE-WIDTH FANS WITH WHEELS

SIZE 12	CFM	OV	1"SP		1½"SP		2"SP		3"SP		4"SP		5"SP		6"SP		7"SP		8"SP			
			RPM	BHP	RPM	BHP	RPM	BHP	RPM	BHP	RPM	BHP	RPM	BHP	RPM	BHP	RPM	BHP	RPM	BHP	RPM	BHP
Max. safe speeds Class 1=3280 RPM Class 2=4270 RPM	1000	1170	1618	0.55	1840	0.66	2035	0.78	2382	1.05	2706	1.37	3018	1.72	3324	2.12						
	1300	1520	1837	0.66	2034	0.79	2212	0.93	2538	1.24	2822	1.57	3079	1.93	3327	2.31	3575	2.78	3814	3.29		
	1600	1871	2080	0.81	2255	0.96	2418	1.13	2719	1.48	2989	1.85	3230	2.23	3462	2.67	3674	3.16	3875	3.67		
	1900	2222	2340	1.01	2499	1.19	2645	1.37	2921	1.75	3167	2.16	3404	2.61	3620	3.12	3826	3.65	4026	4.22		
	2100	2456	2521	1.18	2666	1.37	2808	1.57	3066	1.98	3309	2.42	3529	2.92	3734	3.45	3938	4.03	4128	4.60		
	2400	2807	2802	1.48	2930	1.69	3058	1.92	3300	2.38	3523	2.89	3728	3.44	3930	4.04	4125	4.66				
	2700	3158	3089	1.85	3205	2.09	3320	2.33	3544	2.89	3749	3.46	3952	4.08	4141	4.71						
	3000	3509	3382	2.30	3488	2.57	3594	2.88	3797	3.50	3991	4.14	4186	4.82								

SIZE 15	CFM	OV	1"SP		1½"SP		2"SP		3"SP		4"SP		5"SP		6"SP		7"SP		8"SP			
			RPM	BHP	RPM	BHP	RPM	BHP	RPM	BHP	RPM	BHP	RPM	BHP	RPM	BHP	RPM	BHP	RPM	BHP	RPM	BHP
Max. safe speeds Class 1=2580 RPM Class 2=3360 RPM	1400	1085	1285	0.64	1472	0.81	1634	0.98	1924	1.38	2200	1.84	2475	2.39	2705	3.31	2914	4.02	3128	4.82		
	1800	1395	1440	0.78	1606	0.97	1755	1.17	2028	1.61	2265	2.09	2484	2.63	2705	3.31	2914	4.02	3128	4.82		
	2200	1705	1610	0.96	1762	1.18	1900	1.40	2149	1.89	2380	2.43	2582	3.05	2774	3.74	2954	4.45	3135	5.24		
	2600	2016	1792	1.19	1931	1.44	2055	1.69	2291	2.24	2499	2.85	2697	3.55	2880	4.28	3053	5.04	3216	5.85		
	3000	2326	1984	1.49	2109	1.77	2227	2.05	2446	2.67	2645	3.39	2826	4.13	3004	4.93	3173	5.77	3326	6.59		
	3400	2636	2186	1.86	2296	2.16	2404	2.48	2607	3.21	2799	4.00	2972	4.81	3136	5.64	3296	6.53				
	3800	2936	2393	2.30	2494	2.66	2594	3.06	2782	3.87	2960	4.71	3123	5.56	3287	6.50						
	4200	3256	2603	2.89	2694	3.30	2785	3.73	2965	4.64	3131	5.54	3290	6.47								

SIZE 18	CFM	OV	1"SP		2"SP		3"SP		4"SP		6"SP		8"SP		10"SP		12"SP		14"SP		
			RPM	BHP	RPM	BHP	RPM	BHP	RPM	BHP	RPM	BHP	RPM	BHP	RPM	BHP	RPM	BHP	RPM	BHP	RPM
Max. safe speeds Class 1=2100 RPM Class 2=2735 RPM Class 3=3525 RPM	2000	1042	926	0.69	1255	1.13	1548	1.69	1794	2.32											
	2900	1510	1087	0.93	1317	1.41	1545	2.00	1778	2.72											
	3800	1979	1281	1.30	1476	1.89	1653	2.52	1824	3.31	2179	5.21	2516	7.35							
	4700	2448	1495	1.83	1663	2.54	1820	3.40	1964	4.26	2245	6.18	2526	8.41	2811	10.9					
	5600	2917	1716	2.54	1863	3.47	2003	4.46	2132	5.45	2379	7.56	2613	9.82	2843	12.3	3082	15.1	3322	18.1	
	6500	3385	1944	3.60	2077	4.67	2201	5.77	2320	6.92	2546	9.30	2749	11.7	2947	14.2	3153	17.0	3355	20.1	
	7400	3854	2177	4.97	2298	6.18	2410	7.40	2518	8.67	2721	11.3	2916	14.0	3099	16.7	3272	19.5	3450	22.6	
	8300	4323	2411	6.66	2524	8.01	2629	9.40	2727	10.8	2916	13.7	3097	16.7	3268	19.7	3434	22.8			

SIZE 22	CFM	OV	1"SP		2"SP		3"SP		4"SP		6"SP		8"SP		10"SP		12"SP		14"SP			
			RPM	BHP	RPM	BHP	RPM	BHP	RPM	BHP	RPM	BHP	RPM	BHP	RPM	BHP	RPM	BHP	RPM	BHP	RPM	BHP
Max. safe speeds Class 1=1770 RPM Class 2=2305 RPM Class 3=2900 RPM	3000	1053	794	0.88	1066	1.63	1300	2.64	1505	4.00												
	4300	1509	920	1.21	1126	1.96	1325	2.98	1511	4.30	1839	7.48										
	5600	1965	1085	1.74	1249	2.58	1405	3.67	1559	4.95	1854	8.05	2124	11.8	2377	16.2	2607	21.0				
	6900	2421	1265	2.51	1402	3.60	1534	4.79	1659	6.06	1916	9.19	2155	12.8	2393	17.1	2610	21.9	2811	26.9		
	8200	2877	1453	3.70	1574	4.97	1685	6.26	1794	7.64	2012	10.8	2226	14.4	2434	18.6	2635	23.2	2825	28.2		
	9500	3333	1643	5.23	1754	6.73	1856	8.21	1949	9.68	2137	12.9	2328	16.7	2507	20.7	2688	25.3	2866	30.3		
	10800	3789	1835	7.15	1940	8.92	2030	10.5	2118	12.2	2288	15.8	2450	19.5	2615	23.7	2779	28.3				
	12100	4246	2030	9.52	2127	11.5	2214	13.5	2294	15.3	2448	19.1	2595	23.1	2746	27.5	2893	32.1				

Performance certified is for installation Type B: Free inlet, Ducted outlet. Power rating (BHP) does not include transmission losses. Performance ratings do not include the effects of aperturancs (accessories).

PERFORMANCE FOR SINGLE-WIDTH FANS WITH WHEELS

SIZE 24	CFM	OV	1"SP		2"SP		3"SP		4"SP		6"SP		8"SP		10"SP		12"SP		14"SP	
			RPM	BHP	RPM	BHP	RPM	BHP	RPM	BHP	RPM	BHP	RPM	BHP	RPM	BHP	RPM	BHP	RPM	BHP
Max. safe speeds Class 1=1605 RPM Class 2=2090 RPM Class 3=2635 RPM	3000	870	694	0.91	964	1.81	1190	3.09												
	5000	1449	820	1.34	1009	2.22	1194	3.49	1367	5.07	1677	8.94								
	7000	2029	1008	2.16	1152	3.27	1290	4.59	1426	6.14	1688	9.83	1930	14.2	2155	19.3	2371	25.2		
	9000	2609	1217	3.59	1335	4.97	1447	6.46	1558	8.11	1767	11.7	1975	16.1	2180	21.2	2373	26.8	2553	32.8
	11000	3188	1433	5.67	1538	7.40	1634	9.12	1725	10.9	1904	14.8	2079	19.2	2253	24.2	2424	29.7	2583	35.5
	13000	3768	1654	8.50	1750	10.6	1835	12.7	1916	14.7	2069	18.9	2223	23.6	2370	28.5	2515	33.9		
	15000	4348	1878	12.2	1967	14.8	2045	17.1	2118	19.4	2256	24.1	2388	29.0						
	17000	4928	2104	16.9	2186	19.9	2260	22.7	2326	25.3	2453	30.5	2574	35.9						

SIZE 27	CFM	OV	1"SP		2"SP		3"SP		4"SP		6"SP		8"SP		10"SP		12"SP		14"SP	
			RPM	BHP	RPM	BHP	RPM	BHP	RPM	BHP	RPM	BHP	RPM	BHP	RPM	BHP	RPM	BHP	RPM	BHP
Max. safe speeds Class 1=1420 RPM Class 2=1850 RPM Class 3=2325 RPM	4000	955	623	1.06	862	2.00	1056	3.26	1222	4.80										
	7000	1671	761	1.85	925	3.05	1081	4.53	1228	6.22	1493	10.1	1721	14.5	1924	19.4				
	9000	2148	891	2.77	1021	4.26	1149	5.91	1274	7.74	1510	11.8	1728	16.5	1929	21.7	2107	27.2	2274	33.1
	11000	2625	1033	4.20	1143	5.94	1251	7.81	1353	9.76	1558	14.1	1753	19.0	1941	24.5	2114	30.2	2282	36.6
	13000	3103	1179	6.10	1278	8.15	1370	10.2	1460	12.4	1636	17.1	1809	22.3	1975	27.9	2141	34.0	2296	40.5
	15000	3580	1330	8.58	1420	11.0	1504	13.4	1581	15.8	1737	20.9	1890	26.4	2040	32.3	2186	38.6		
	17000	4057	1483	11.7	1566	14.5	1641	17.1	1713	19.8	1852	25.4	1987	31.2	2122	37.5	2256	44.1		
	19000	4535	1637	15.5	1714	18.6	1785	21.7	1850	24.6	1979	30.8	2102	37.2	2223	43.8				

SIZE 30	CFM	OV	1"SP		2"SP		3"SP		4"SP		6"SP		8"SP		10"SP		12"SP		14"SP	
			RPM	BHP	RPM	BHP	RPM	BHP	RPM	BHP	RPM	BHP	RPM	BHP	RPM	BHP	RPM	BHP	RPM	BHP
Max. safe speeds Class 1=1280 RPM Class 2=1665 RPM Class 3=2095 RPM	7000	1354	617	1.57	793	3.05	953	4.84	1098	6.94										
	9000	1741	701	2.31	842	3.94	978	5.82	1110	8.03	1347	13.1	1553	18.9						
	11000	2128	796	3.33	914	5.15	1031	7.22	1143	9.47	1360	14.7	1554	20.6	1739	27.5				
	13000	2515	900	4.71	1003	6.78	1102	9.01	1200	11.4	1389	16.8	1569	22.9	1742	29.8	1909	37.5	2054	45.3
	15000	2901	1007	6.46	1099	8.79	1185	11.2	1272	13.8	1440	19.5	1602	25.8	1764	32.9	1920	40.8	2059	48.6
	17000	3288	1116	8.65	1200	11.3	1279	14.0	1356	16.8	1506	22.8	1652	29.4	1798	36.6	1937	44.3	2077	52.8
	19000	3675	1226	11.3	1305	14.3	1378	17.3	1447	20.3	1583	26.8	1715	33.6	1847	41.1	1979	49.2		
	21000	4062	1337	14.5	1413	17.9	1479	21.1	1543	24.4	1666	31.2	1790	38.6	1912	46.4	2031	54.7		

SIZE 33	CFM	OV	1"SP		2"SP		3"SP		4"SP		6"SP		8"SP		10"SP		12"SP		14"SP	
			RPM	BHP	RPM	BHP	RPM	BHP	RPM	BHP	RPM	BHP	RPM	BHP	RPM	BHP	RPM	BHP	RPM	BHP
Max. safe speeds Class 1=1175 RPM Class 2=1515 RPM Class 3=1905 RPM	7000	1118	527	1.49	709	3.19	862	5.26	996	7.69										
	10000	1597	607	2.47	747	4.28	881	6.51	1003	9.07	1223	15.1								
	13000	2077	711	3.99	823	6.09	930	8.41	1036	11.1	1234	17.3	1410	24.3	1576	32.4	1730	41.3	1865	50.3
	16000	2556	827	6.14	920	8.65	1010	11.3	1099	14.1	1270	20.5	1433	27.8	1589	36.2	1732	45.1	1870	55.0
	19000	3035	948	9.00	1029	12.0	1106	15.0	1182	18.1	1331	24.9	1475	32.4	1614	40.7	1745	49.6	1878	59.9
	21000	3355	1030	11.3	1105	14.8	1177	18.1	1245	21.4	1381	28.4	1514	36.2	1647	44.9	1767	53.7	1894	64.0
	24000	3834	1156	15.6	1224	19.8	1287	23.6	1350	27.3	1469	34.9	1588	43.2	1703	51.9	1817	61.2		
	27000	4313	1283	20.9	1345	25.7	1404	30.2	1460	34.4	1568	42.8	1675	51.6	1781	60.9	1882	70.5		

SIZE 36	CFM	OV	1"SP		2"SP		3"SP		4"SP		6"SP		8"SP		10"SP		12"SP		14"SP	
			RPM	BHP	RPM	BHP	RPM	BHP	RPM	BHP	RPM	BHP	RPM	BHP	RPM	BHP	RPM	BHP	RPM	BHP
Max. safe speeds Class 1=1045 RPM Class 2=1360 RPM Class 3=1715 RPM	10000	1305	503	2.16	658	4.45	797	7.26	915	10.4	1119	17.7	1290	26.1	1445	35.8	1581	45.9	1704	56.7
	14000	1828	595	3.51	709	6.05	821	9.02	930	12.5	1127	20.4	1297	29.5	1444	39.2	1582	50.0	1714	62.1
	18000	2350	707	5.59	797	8.55	885	11.8	974	15.5	1145	23.8	1308	33.4	1454	43.9	1585	54.9		
	22000	2872	828	8.56	902	12.0	973	15.6	1047	19.6	1192	28.3	1333	38.1	1471	49.2	1599	61.0		
	26000	3394	952	12.5	1016	16.5	1078	20.6	1139	24.9	1263	34.3	1384	44.5	1505	55.8	1624	68.2		
	30000	3916	1080	17.8	1136	22.3	1190	26.9	1244	31.7	1352	41.9	1458	52.7	1562	64.3	1669	77.1		
	34000	4439	1209	24.4	1260	29.5	1309	34.7	1357	40.0	1450	50.8	1544	62.5	1637	74.7				
	38000	4961	1340	32.7	1386	38.4	1430	44.2	1473	49.9	1559	61.9	1644	74.4						

SIZE 40	CFM	OV	1"SP		2"SP		3"SP		4"SP		6"SP		8"SP		10"SP		12"SP		14"SP	
			RPM	BHP	RPM	BHP	RPM	BHP	RPM	BHP	RPM	BHP	RPM	BHP	RPM	BHP	RPM	BHP	RPM	BHP
Max. safe speeds Class 1= 950 RPM Class 2=1235 RPM Class 3=1555 RPM	12000	1289	450	2.50	587	5.05	711	8.18	820	11.8										
	16000	1719	519	3.81	623	6.58	725	9.86	824	13.6	1005	22.5	1160	32.6						
	20000	2148	601	5.68	684	8.82	769	12.4	851	16.3	1011	25.4	1163	36.2	1295	47.5	1424	60.7		
	24000	2578	690	8.26	761	11.9	830	15.7	900	20.0	1039	29.5	1172	40.2	1303	52.5	1419	65.2		
	28000	3008	781	11.6	844	15.8	905	20.1	964	24.6	1081	34.5	1200	45.7	1318	58.2	1427	71.1	1538	85.8
	32000	3437	875	15.8	932	20.6	985	25.4	1038	30.4	1140	40.9	1246	52.7	1350	65.4	1451	78.9	1554	93.9
	36000	3867	969	21.0	1021	26.5	1071	31.9	1117	37.2	1212	48.9	1303	60.9	1394	73.9	1487	88.1		
	40000	4296	1065	27.3	1113	33.4	1158	39.5	1203	45.6	1286	57.7	1370	70.8	1452	84.3	1537	99.1		

Performance certified is for installation Type B: Free inlet, Ducted outlet. Power rating (BHP) does not include transmission losses. Performance ratings do not include the effects of appurtenances (accessories).

PERFORMANCE FOR SINGLE-WIDTH FANS WITH WHEELS

SIZE 44 Max. safe speeds Class 1= 880 RPM Class 2=1120 RPM Class 3=1410 RPM	CFM	OV	1"SP		2"SP		3"SP		4"SP		6"SP		8"SP		10"SP		12"SP		14"SP			
			RPM	BHP	RPM	BHP	RPM	BHP	RPM	BHP	RPM	BHP	RPM	BHP	RPM	BHP	RPM	BHP	RPM	BHP	RPM	BHP
	14000	1229	400	2.90	527	5.95	641	9.75	742	14.2	907	27.7	1049	40.2								
	20000	1756	476	4.87	568	8.34	659	12.3	747	17.0	915	31.5	1050	44.6	1171	58.8	1286	74.7				
	25000	2195	552	7.34	626	11.2	701	15.7	775	20.6	942	36.8	1063	50.2	1176	64.7	1289	81.6	1389	98.6		
	30000	2634	634	10.7	698	15.3	759	20.1	821	25.3												
	35000	3073	720	15.1	775	20.3	829	25.7	881	31.3	985	43.5	1092	57.5	1195	72.5	1296	89.2	1396	107		
	40000	3512	806	20.6	857	26.7	905	32.8	951	39.0	1043	52.1	1134	66.1	1227	82.1	1318	98.9	1406	117		
	45000	3951	894	27.5	941	34.3	984	41.1	1027	48.1	1107	61.9	1190	77.3	1270	93.1	1355	111				
	50000	4390	983	35.9	1026	43.6	1066	51.1	1105	58.7	1179	73.8	1253	90.0	1328	107	1399	125				

SIZE 49 Max. safe speeds Class 1= 780 RPM Class 2=1020 RPM Class 3=1280 RPM	CFM	OV	1"SP		2"SP		3"SP		4"SP		6"SP		8"SP		10"SP		12"SP		14"SP			
			RPM	BHP	RPM	BHP	RPM	BHP	RPM	BHP	RPM	BHP	RPM	BHP	RPM	BHP	RPM	BHP	RPM	BHP	RPM	BHP
	17000	1232	363	3.52	479	7.22	584	11.9	676	17.3												
	24000	1739	429	5.78	514	9.97	598	14.9	679	20.6	826	33.7										
	30000	2174	498	8.73	566	13.5	634	18.8	701	24.6	831	38.0	953	53.7	1066	71.3	1167	90.0				
	36000	2609	572	12.7	630	18.2	686	24.0	742	30.1	855	44.4	962	60.1	1071	78.7	1168	97.9	1261	119		
	42000	3043	648	17.8	699	24.1	748	30.7	796	37.4	893	52.4	990	69.1	1083	87.0	1177	108	1266	129		
	48000	3478	726	24.4	772	31.6	816	39.0	858	46.3	942	62.1	1026	79.3	1111	98.2	1195	119	1277	141		
	54000	3913	805	32.5	848	40.8	887	48.9	925	56.9	1001	74.3	1076	92.5	1151	112	1227	133				
	60000	4348	885	42.4	924	51.6	961	60.7	996	69.7	1065	88.3	1132	107	1199	128	1268	150				

SIZE 54 Max. safe speeds Class 1= 710 RPM Class 2= 920 RPM Class 3=1175 RPM	CFM	OV	1"SP		2"SP		3"SP		4"SP		6"SP		8"SP		10"SP		12"SP		14"SP			
			RPM	BHP	RPM	BHP	RPM	BHP	RPM	BHP	RPM	BHP	RPM	BHP	RPM	BHP	RPM	BHP	RPM	BHP	RPM	BHP
	20000	1182	324	4.13	432	8.64	526	14.2	610	20.9												
	30000	1773	392	7.33	467	12.5	542	18.5	612	25.3	744	41.4	862	60.3								
	40000	2364	479	12.7	535	18.8	592	25.5	648	33.0	760	50.0	863	68.9	964	91.2	1052	114				
	50000	2955	571	20.5	619	28.1	664	35.7	709	44.0	798	61.8	887	82.0	976	105	1061	129	1139	155		
	60000	3546	667	31.3	708	40.4	747	49.5	785	58.7	859	78.3	933	99.4	1009	123	1082	148	1156	175		
	65000	3842	715	38.0	754	48.0	791	57.8	826	67.6	895	88.4	964	110	1032	134	1102	160	1171	188		
	70000	4137	764	45.8	801	56.6	835	67.0	869	77.8	934	99.7	997	123	1062	147	1127	174				
	75000	4433	813	54.6	848	66.1	881	77.7	913	89.0	973	112	1034	136	1092	161	1153	188				

SIZE 60 Max. safe speeds Class 1= 640 RPM Class 2= 830 RPM Class 3=1045 RPM	CFM	OV	1"SP		2"SP		3"SP		4"SP		6"SP		8"SP		10"SP		12"SP		14"SP			
			RPM	BHP	RPM	BHP	RPM	BHP	RPM	BHP	RPM	BHP	RPM	BHP	RPM	BHP	RPM	BHP	RPM	BHP	RPM	BHP
	25000	1208	295	5.17	392	10.8	477	17.7	552	25.7												
	35000	1691	345	8.30	416	14.5	486	21.8	554	30.3	673	49.5										
	45000	2174	407	13.1	463	20.2	518	28.1	573	37.0	679	57.1	777	80.3	871	107						
	55000	2657	474	19.8	520	28.1	566	37.0	610	46.4	701	67.6	789	91.7	875	119	954	148	1030	180		
	65000	3140	543	28.8	585	38.7	622	48.4	661	58.8	738	81.6	813	106	889	134	962	164	1034	197		
	75000	3623	614	40.4	651	51.9	686	63.1	719	74.5	785	98.7	852	126	917	154	984	185				
	85000	4106	686	55.0	720	68.1	752	81.1	781	93.7	840	120	900	149	957	178	1017	211				
	95000	4589	759	73.1	790	87.8	819	102	847	117	900	146	953	176	1005	207						

SIZE 66 Max. safe speeds Class 1= 585 RPM Class 2= 755 RPM Class 3= 950 RPM	CFM	OV	1"SP		2"SP		3"SP		4"SP		6"SP		8"SP		10"SP		12"SP		14"SP			
			RPM	BHP	RPM	BHP	RPM	BHP	RPM	BHP	RPM	BHP	RPM	BHP	RPM	BHP	RPM	BHP	RPM	BHP	RPM	BHP
	30000	1198	267	6.18	355	12.9	434	21.4	502	31.1												
	42000	1677	312	9.88	377	17.3	440	26.0	503	36.4	613	60.1										
	54000	2156	368	15.6	419	24.2	468	33.5	520	44.3	618	68.9	707	96.9	792	129						
	66000	2635	428	23.5	470	33.5	513	44.3	554	55.8	636	81.2	716	110	794	143	869	179	938	218		
	78000	3114	490	34.1	528	45.8	563	57.7	599	70.6	669	97.7	739	128	807	161	874	198	939	237		
	90000	3593	554	47.8	588	61.7	619	74.9	650	89.0	712	119	771	150	832	184	892	222				
	102000	4072	620	65.3	650	80.7	678	96.1	706	111	760	143	814	178	866	213	920	252				
	114000	4551	685	86.8	713	104	739	121	765	139	814	173	861	209	910	248						

SIZE 73 Max. safe speeds Class 1= 530 RPM Class 2= 685 RPM Class 3= 880 RPM	CFM	OV	1"SP		2"SP		3"SP		4"SP		6"SP		8"SP		10"SP		12"SP		14"SP			
			RPM	BHP	RPM	BHP	RPM	BHP	RPM	BHP	RPM	BHP	RPM	BHP	RPM	BHP	RPM	BHP	RPM	BHP	RPM	BHP
	40000	1305	250	8.43	324	16.8	393	27.3	453	39.3												
	55000	1795	294	13.6	349	23.0	403	33.9	457	46.7	553	75.4	640	109								
	70000	2285	347	21.3	390	32.2	434	44.3	477	57.5	560	87.5	642	123	715	162	784	204				
	85000	2774	403	32.2	440	45.0	476	58.3	512	73.1	582	104	652	140	720	181	785	224	848	273		
	100000	3264	461	46.5	494	61.7	524	76.7	555	92.6	615	126	676	164	737	206	796	251	853	299		
	115000	3753	521	65.2	550	82.7	578	100	604	117	657	154	709	194	762	237	816	284	867	332		
	130000	4243	581	88.5	608	108	633	128	657	148	704	188	751	230	798	276	842	322				
	145000	4732	642	117	666	140	689	162	712	184	755	228	797	273	838	320	879	370				

Performance certified is for installation Type B: Free inlet, Ducted outlet. Power rating (BHP) does not include transmission losses. Performance ratings do not include the effects of appurtenances (accessories).

MOTOR PEDESTAL DIMENSIONS, CAPABILITIES

ARRANGEMENT 8 MOTOR PEDESTAL DIMENSIONS

These approximate dimensions can be used to estimate the overall size of Arrangement 8 fans. Add the appropriate dimensions below to the fan dimensions on page 22.

Note: Coupling gap is based on the Falk Steelflex coupling sizes shown. As the gap will vary with other coupling sizes or types, so will the Arrangement 8 motor pedestal dimensions. Specific motor and coupling data is required to determine exact dimensions.

DIMENSIONS [INCHES]

Motor frame size	Coupling		0-0*		H-H*			
					Open		TE	
	Size	Gap	Min.	Max.	Min.	Max.	Min.	Max.
213T -215T	1050T10	1/8	1 3/8	5 1/2	15 7/8	17 3/8	17 7/8	20
254T -256T	1060T10	1/8	1	5 7/8	20 5/8	22 1/2	22 1/2	25 1/2
284T -286T	1070T10	1/8	1 1/2	6 3/8	23 1/2	25 1/8	25 3/8	28 3/8
284TS-286TS	1070T10	1/8	1 1/2	6 1/2	22 1/8	23 3/4	24 1/8	27 1/8
324T -326T	1080T10	1/8	1	6 3/4	26 1/8	27 3/4	28 1/4	31 7/8
324TS-326TS	1080T10	1/8	1	6 3/4	24 5/8	26 1/8	26 3/4	30 3/8
364T -365T	1090T10	1/8	1 1/8	7	28 1/4	29 7/8	32 1/2	34 1/8
364TS-365TS	1090T10	1/8	1 5/8	7	26 5/8	27 5/8	30 3/8	32
404T -405T	1090T10	1/8	2 3/8	8 3/4	32 5/8	34 1/4	37 3/8	39
404TS-405TS	1090T10	1/8	2 3/8	8 3/4	29 5/8	31 1/4	34 3/8	36
444T -445T	1100T10	3/16	1 5/8	9 3/8	37 3/8	40	42	45 1/8
444TS-445TS	1100T10	3/16	2 1/8	9 3/8	34 1/8	36 1/4	38 3/8	41 3/8

*H-H and 0-0 based on several major motor manufacturers—consult **nyb** for exact dimensions. Tolerance: $\pm 1/8"$

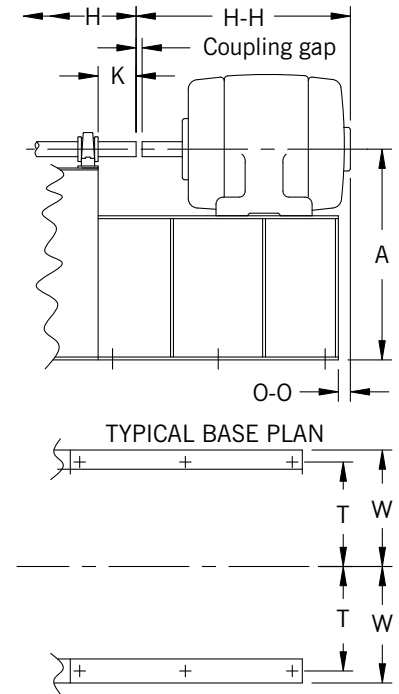

ARRANGEMENT 9 PEDESTALS—MOTOR SIZE CAPABILITY

Arrangement 9 is a space-efficient package consisting of fan, motor, V-belt drive, and accessories. Motors are mounted on the left or right side of the pedestal as space permits. C-NW is not a NEMA standard dimension and varies by manufacturer. As a result, C-NW must be checked in every instance. To determine if Arrangement 9 is a workable configuration, compare the desired motor's frame size with the frame size shown for the appropriate fan below. If the frame size and C-NW dimension are no larger than that shown, the combination is satisfactory. In all cases, C-NW is the final determining factor. The C-NW dimension for the desired motor must be equal to or less than the maximum shown. If the C-NW dimension is larger than that shown, a different motor, fan, or arrangement must be selected.

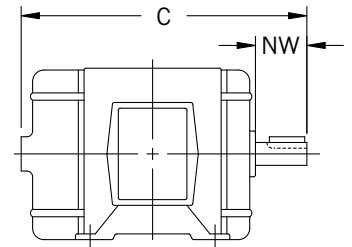

DIMENSIONS [INCHES]

Size	Class 1						Class 2						Class 3					
	Standard fans			Heat fans			Standard fans			Heat fans			Standard fans			Heat fans		
	Max. C-NW	Motor frame size		Max. C-NW	Motor frame size		Max. C-NW	Motor frame size		Max. C-NW	Motor frame size		Max. C-NW	Motor frame size		Max. C-NW	Motor frame size	
		TEFC	ODP		TEFC	ODP		TEFC	ODP		TEFC	ODP		TEFC	ODP		TEFC	ODP
12	12 1/2	145T	145T	11 1/4	145T	145T	13 1/2	145T	145T	12 1/4	145T	145T	—	—	—	—	—	—
15	13 1/2	184T	184T	12 1/4	145T	184T	15 5/16	184T	184T	14 1/16	184T	184T	—	—	—	—	—	—
18	13 9/16	184T	213T	12 5/16	145T	184T	16 13/16	213T	215T	15 9/16	213T	215T	15 1/2	213T	215T	14 1/4	184T	213T
22	16 13/16	215T	254T	15 9/16	213T	215T	20 7/16	215T	284T	19 3/16	215T	256T	20 1/4	254T	256T	19	215T	256T
24	16 15/16	215T	254T	15 11/16	213T	215T	22 3/16	256T	286T	20 15/16	254T	286T	21 1/4	254T	286T	20	254T	256T
27	20 7/16	254T	256T	19 3/16	215T	256T	22 15/16	256T	326T	21 11/16	256T	286T	22 1/4	256T	286T	21	254T	286T
30	20 7/16	254T	284T	19 3/16	215T	256T	24 1/2	324T	365T	23 1/4	284T	326T	25	324T	365T	23 3/4	286T	326T
33	22 3/16	256T	284T	20 15/16	254T	286T	27 3/4	326T	405T	26 1/2	324T	365T	27 1/2	326T	405T	26 1/4	326T	365T
36	22 1/4	256T	284T	21	254T	286T	27 13/16	364T	405T	26 9/16	326T	365T	23 7/8	326T	365T	22 5/8	324T	365T
40	27 3/4	326T	405T	26 1/2	326T	365T	29 1/4	365T	405T	28	365T	405T	27	326T	405T	25 3/4	324T	365T
44	27 3/4	326T	405T	26 1/2	326T	365T	32 3/4	405T	405T	31 1/2	365T	405T	30	365T	405T	28 3/4	365T	405T
49	29 1/4	365T	405T	28	365T	405T	32 3/4	405T	405T	31 1/2	365T	405T	33	405T	405T	31 3/4	405T	405T
54	29 1/4	365T	405T	28	365T	405T	37 3/4	405T	405T	36 1/2	405T	405T	36	405T	405T	34 3/4	405T	405T
60	29 1/4	365T	405T	28	365T	405T	37 3/4	405T	405T	36 1/2	405T	405T	41	405T	405T	39 3/4	405T	405T
66	32 3/4	405T	405T	31 1/2	365T	405T	37 3/4	405T	405T	36 1/2	405T	405T	44	405T	405T	42 3/4	405T	405T
73	32 3/4	405T	405T	31 1/2	365T	405T	46 3/4	405T	405T	45 1/2	405T	405T	49	405T	405T	47 3/4	405T	405T

Motors on 326T frames and larger should be checked for weight. Arrangement 9 fans can accommodate motors weighing up to 600 lbs. Arrangement 9 fans provisioned with heavy duty slide rails can accommodate motors weighing up to 1000 lbs. Arrangement 1 fans with unitary bases are required for motors weighing more than 1000 lbs. Tolerance: $\pm 1/8"$

FLANGE DIMENSIONS

FLANGED INLET OPTION

Holes furnished on vertical centerline.

Note: Inlet-flange angles:
 Size 12 1" x 1" x 1/8"
 Sizes 15-22 . . 1 1/2" x 1 1/2" x 3/16"
 Sizes 24-73 . . 2" x 2" x 3/16"

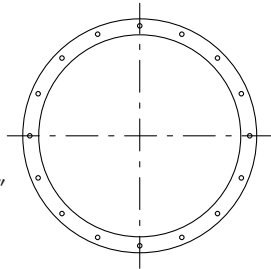

DIMENSIONS [INCHES]

Size	ID	BC	OD	Holes	
				No.	Dia.
12	13 1/2	14 5/8	15 1/2	8	7/16
15	16 3/8	17 7/8	19 3/8	8	7/16
18	20	21 3/4	23	16	9/16
22	24 3/8	26 1/8	27 3/8	16	9/16
24	26 7/8	29 1/8	30 7/8	16	9/16
27	29 1/2	31 3/4	33 1/2	16	9/16
30	32 7/8	35 1/8	36 7/8	16	9/16
33	36 1/8	38 3/8	40 1/8	16	9/16
36	40 1/8	42 3/8	44 1/8	16	9/16
40	43 7/8	46 1/8	47 7/8	24	9/16
44	48 7/8	51 1/8	52 7/8	24	9/16
49	53 7/8	56 1/8	57 7/8	24	9/16
54	59 3/8	61 5/8	63 3/8	24	9/16
60	66 1/8	68 3/8	70 1/8	32	9/16
66	72 5/8	74 7/8	76 5/8	32	9/16
73	80 5/8	82 7/8	84 5/8	32	9/16

Tolerance: ± 1/8"

FLANGED OUTLET OPTION

1. Flange face mounted flush with outside edge of housing discharge.
2. Holes furnished on 4" centers from centerlines.
3. For alloy construction and Arrangements 1, 3, and 10 Down Blast discharge:
 Sizes 12-15 . . 1" x 1" x 1/8" angle.
 Sizes 18-22 . . 1 1/4" x 1 1/4" x 3/16" angle.

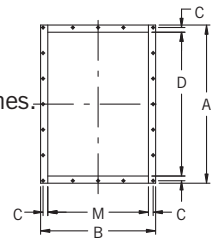

NOTE: Outlet-flange angles or material gauge:
 Sizes 12-22* . . 7 gauge plate.
 Sizes 24-33 . . . 1 1/2" x 1 1/2" x 3/16" angle.
 Sizes 36-73 . . . 2" x 2" x 3/16" angle.

DIMENSIONS [INCHES]

Size	A*	B†*	C	D•	M•†	Holes/flange		Hole dia.
						Sides	†Top/bottom	
12	15 3/4	11 3/8	5/8	13 5/8	9 3/8	3	3	5/16
15	18 3/4	13 3/8	5/8	16 3/4	11 3/8	5	3	5/16
18	22 15/16	16 3/8	3/4	20 1/2	13 7/8	5	3	7/16
22	27 5/16	19 3/8	3/4	24 7/8	16 7/8	7	3	7/16
24	30 3/8	21 1/2	7/8	27 3/8	18 1/2	7	5	7/16
27	33 1/4	23 3/8	7/8	30 1/4	20 3/8	9	5	7/16
30	36 1/2	25 5/8	7/8	33 1/2	22 5/8	9	5	7/16
33	39 7/8	27 7/8	7/8	36 7/8	24 7/8	9	5	7/16
36	44 3/4	31 1/2	1 1/8	40 3/4	27 1/2	11	7	9/16
40	48 7/8	34 3/8	1 1/8	44 7/8	30 3/8	11	7	9/16
44	53 5/8	37 1/2	1 1/8	49 5/8	33 1/2	13	7	9/16
49	58 5/8	40 7/8	1 1/8	54 5/8	36 7/8	15	9	9/16
54	64 3/8	44 3/4	1 1/8	60 3/8	40 3/4	15	9	9/16
60	70 7/8	49	1 1/8	66 7/8	45	17	11	9/16
66	77 1/2	53 1/2	1 1/8	73 1/2	49 1/2	19	11	9/16
73	85 1/4	58 3/4	1 1/8	81 1/4	54 3/4	21	13	9/16

† Dimensions may vary with narrow-width construction.

Tolerance: ± 1/8"

- Dimension shown is inside flange, outside housing, Deduct housing material thicknesses to determine inside dimensions of discharge.
- * Materials of construction for mild steel only. Alloy construction uses angle on all sizes. A and B dimensions will vary in Sizes 12-22.

UNIQUE FANS FOR AIR-HANDLING

DOUBLE-WIDTH ACOUSTAFOIL

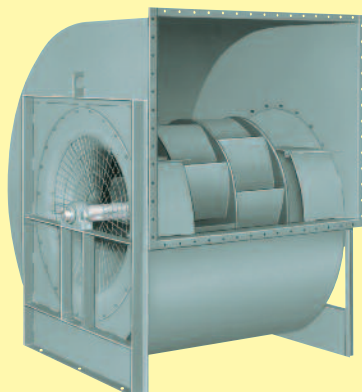

Capacities to 350,000 CFM, 14" WG

A complete double-width offering to suit AMCA Class 1, 2, and 3 performance standards...airfoil-wheel design for quiet, efficient performance with non-overloading horsepower characteristic... stable performance, when coupled with **nyb** inlet dampers, is particularly well-suited to the variable-air-volume systems.

PLENUM

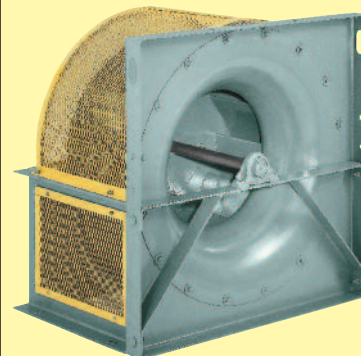

Capacities to 180,000 CFM, 13" WG

Ideal for packaged or built-up air-handling systems where reduced size and weight is critical... available with two wheel choices: high-efficiency Acoustafoil and ultra-quiet Acoustafoil-Q... consider New York Blower Plenum Fans for the utmost in system value and application flexibility.

UNITARY BASE DIMENSIONS

Structural-steel channel base provides a factory-designed package of Arrangement 1 or 3 fan, motor, drive, and guard. Also available with rubber-in-shear or spring isolation. Built-in motor rails provide for adjustment of belt tension.

Unitary base with isolation is also available for Arrangement 4, 8, and 9 fans.

NOTE: Down Blast discharge requires special construction. Also, some larger fans on unitary bases cannot be shipped as an assembled package.

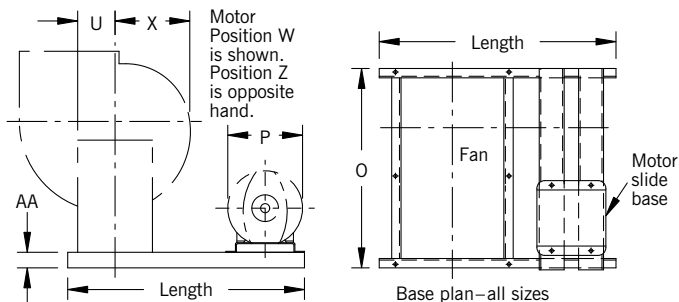

Approximate base length = $U + X + P + 16$

U = from fan base dimension drawing on pages 22 and 23.

X = dimension from fan centerline to edge of scroll nearest motor. Dimension varies with discharge and motor position. Refer to dimensional drawings on pages 22 and 23.

P = diameter of motor from table at upper right.

16 = constant—allows for motor clearance.

NOTE: These dimensions are only approximate. Exact dimensions furnished after order is placed.

DIMENSIONS [INCHES]

Size	AA	O		
		Class 1	Class 2	Class 3
12	3*†	25	26	—
15	3*†	28	29 ³ / ₄	—
18	3*†	30 ¹ / ₂	33 ³ / ₄	32
22	3*†	36 ⁷ / ₈	40 ¹ / ₂	39 ³ / ₄
24	3*†	39 ¹ / ₈	44 ³ / ₈	42 ³ / ₈
27	4†	44 ³ / ₄	47 ¹ / ₄	45 ¹ / ₂
30	4†	47	51	50 ¹ / ₂
33	4†	51	56 ¹ / ₂	55 ¹ / ₄
36	6•	53 ⁵ / ₈	59 ¹ / ₄	59 ³ / ₈
40	6•	66 ¹ / ₈	67 ⁵ / ₈	65 ³ / ₈
44	6•	69 ¹ / ₈	74 ¹ / ₈	71 ³ / ₈
49	6•	74 ¹ / ₈	77 ⁵ / ₈	77 ⁷ / ₈
54	6•	79 ⁷ / ₈	88 ³ / ₈	86 ⁵ / ₈
60	6•	84 ¹ / ₈	92 ⁵ / ₈	95 ⁷ / ₈
66	6•	94 ¹ / ₈	99 ¹ / ₈	105 ³ / ₈
73	6•	99 ³ / ₈	113 ³ / ₈	115 ⁵ / ₈

*4" channel used for motors larger than 215T up to 286T. Tolerance: $\pm 1/8$ "

†6" channel used for motors larger than 286T.

•8" channel used for base lengths exceeding 100".

P DIMENSIONS [INCHES]

Size	Typical TEFC motor
143T	7 ³ / ₄
145T	7 ³ / ₄
182T	9 ¹ / ₂
184T	9 ¹ / ₂
213T	12
215T	12
254T	14 ¹ / ₂
256T	14 ¹ / ₂
284T	15 ¹ / ₄
286T	15 ¹ / ₄
324T	17 ³ / ₈
326T	17 ³ / ₈
364T	19 ¹ / ₂
365T	19 ¹ / ₂
404T	21 ⁵ / ₈
405T	21 ⁵ / ₈
444T	24 ¹ / ₈
445T	24 ¹ / ₈
447T	24 ¹ / ₈
449T	24 ¹ / ₈

AMCA STANDARD MOTOR-POSITION DESIGNATIONS

Arrangement 1 and 3 motor positions are independent of fan rotation and discharge. Position is determined from drive end of fan shaft as shown in drawing at right.

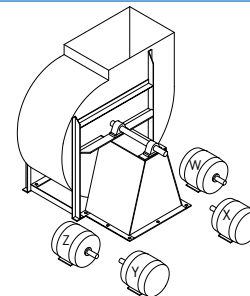

HEAVY-DUTY FANS FOR HIGHER PRESSURES

CLASS IV



Capacities to 170,000 CFM, 20" WG

A heavier-duty extension of the Single-Width Fan design for higher pressure requirements...choice of two wheels for best efficiency: AcoustaFoil for clean, dry airstreams and PLR for moderate amounts of dirt and moisture...temperatures to 750°F.

Capacities to 130,000 CFM, 50" WG

Airfoil-wheel design for high efficiency with non-overloading horsepower characteristic featuring curves which cover a wide range of narrow-width performance at direct-drive motor speeds... well-suited to higher horsepower required for high-pressure performance.

AF

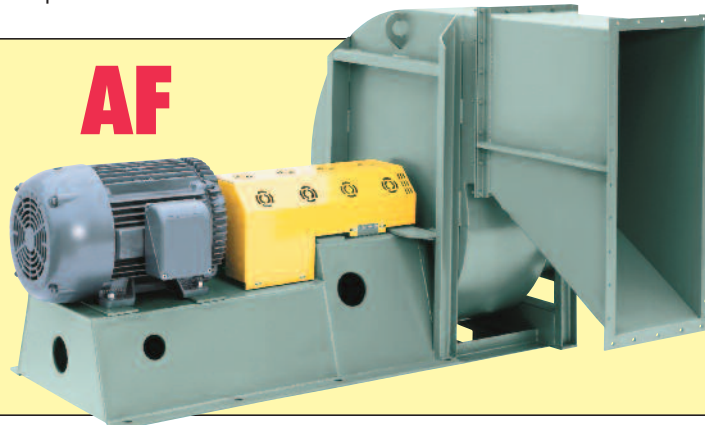

MATERIAL SPECIFICATIONS

U.S. standard sheet gauge to 7 gauge. Dimensions in inches. Weights in pounds. WR² in lb.-ft.².

CLASS 1																					
Size	Housing				Shaft		Bearing		Arr. 1, 8, & 9 bearing pedestal	Wheel						Bare fan weight					
	Arr. 1, 8, & 9		Arr. 3		Arr. 1, 8, & 9	Arr. 3	Arr. 1, 8, & 9	Arr. 3		AcoustaFoil		BC		PLR		AcoustaFoil		BC		PLR	
	Scroll	Side sheets	Scroll	Side sheets						WR ²	Weight	WR ²	Weight	WR ²	Weight	WR ²	Weight	WR ²	Weight	WR ²	Weight
12	16	14	-	-	1	-	A	-	10	1	7	-	-	2	15	102	-	-	-	110	-
15	16	14	-	-	1 3/16	-	A	-	10	3	12	-	-	4	21	137	-	-	-	146	-
18	14	14	-	-	1 3/16	-	A	-	10	10	32	11	36	10	32	202	-	206	-	202	-
22	14	14	-	-	1 7/16	-	A	-	10	22	44	30	59	26	50	279	-	294	-	285	-
24	14	12	12	10	1 7/16	1 11/16	A	A	7	38	71	49	88	43	77	401	396	418	413	407	402
27	14	12	12	10	1 11/16	1 11/16	A	A	7	63	90	72	103	64	91	495	515	508	528	496	516
30	14	12	12	10	1 11/16	1 15/16	A	A	7	91	103	112	126	97	108	573	683	596	706	578	688
33	14	12	12	10	1 15/16	1 15/16	A	A	7	121	119	151	146	131	127	669	749	696	776	677	757
36	12	12	10	10	1 15/16	1 15/16	A	C	7	232	178	265	205	235	181	893	998	920	1025	896	1001
40	10	10	10	10	2 3/16	2 3/16	C	C	1/4	306	188	301	231	310	191	1383	1223	1426	1266	1386	1226
44	10	10	10	10	2 7/16	2 3/16	C	C	1/4	501	260	576	301	506	264	1680	1540	1721	1581	1684	1544
49	10	10	10	10	2 7/16	2 7/16	C	C	1/4	809	344	937	402	903	377	1979	1884	2037	1942	2012	1917
54	10	10	10	10	2 11/16	2 7/16	D	D	1/4	1205	411	1397	483	1344	453	2596	2191	2668	2263	2638	2233
60	10	10	10	10	2 15/16	2 11/16	D	D	1/4	1761	509	2402	648	2330	637	3059	2644	3198	2783	3187	2772
66	10	10	10	10	2 15/16	2 15/16	D	E	1/4	3583	825	4109	956	3915	893	4165	3835	4296	3966	4233	3903
73	10	10	10	10	3 7/16	3 7/16	D	F	1/4	5705	1047	6385	1215	6441	1164	5047	4632	5215	5164	5164	4749

CLASS 2																					
Size	Housing				Shaft		Bearing		Arr. 1, 8, & 9 bearing pedestal	Wheel						Bare fan weight					
	Arr. 1, 8, & 9		Arr. 3		Arr. 1, 8, & 9	Arr. 3	Arr. 1, 8, & 9	Arr. 3		AcoustaFoil		BC		PLR		AcoustaFoil		BC		PLR	
	Scroll	Side sheets	Scroll	Side sheets						WR ²	Weight	WR ²	Weight	WR ²	Weight	WR ²	Weight	WR ²	Weight	WR ²	Weight
12	16	14	-	-	1 3/16	-	A	-	10	1	7	-	-	2	15	107	-	-	-	115	-
15	16	14	-	-	1 7/16	-	A	-	10	3	12	-	-	4	21	147	-	-	-	156	-
18	14	14	-	-	1 11/16	-	A	-	10	10	31	20	48	10	32	221	-	238	-	222	-
22	14	14	-	-	1 11/16	-	A	-	7	22	44	30	68	26	59	334	-	358	-	349	-
24	14	12	12	10	1 11/16	1 11/16	A	A	7	38	70	49	88	43	74	440	485	458	503	444	489
27	14	12	12	10	1 15/16	1 11/16	A	A	7	63	90	72	103	64	91	520	655	533	668	521	656
30	14	12	12	10	1 15/16	1 15/16	C	C	1/4	91	103	111	125	104	115	698	838	620	860	710	850
33	14	12	12	10	2 3/16	1 15/16	C	C	1/4	121	119	151	146	146	137	859	914	886	941	877	932
36	12	12	10	10	2 3/16	2 3/16	D	C	1/4	232	178	267	204	278	206	1068	1193	1094	1219	1096	1221
40	10	10	10	10	2 7/16	2 7/16	D	C	3/8	306	188	309	242	355	214	1558	1298	1612	1352	1584	1324
44	10	10	10	10	2 11/16	2 11/16	D	E	3/8	501	260	584	311	568	289	1910	1845	1961	1896	1939	1874
49	10	10	10	10	2 15/16	2 11/16	D	E	3/8	833	349	937	402	903	377	2244	2119	2297	2172	2272	2147
54	10	10	10	10	3 7/16	2 15/16	D	F	3/8	1244	419	1601	541	1599	520	3024	2739	3146	2861	3125	2840
60	7	7	7	7	3 7/16	3 7/16	D	F	3/8	1822	522	2489	670	2419	660	3862	3637	4010	3785	4000	3775
66	7	7	7	7	3 7/16	3 7/16	D	F	3/8	3674	840	4110	972	4074	922	5015	4235	5147	4367	5097	4317
73	7	7	7	7	3 15/16	3 15/16	D	F	3/8	5833	1079	6382	1229	6442	1179	6214	5734	6364	5884	6314	5834

CLASS 3																
Size	Housing		Shaft		Bearing		Arr. 1, 8, & 9 bearing pedestal	Wheel				Bare fan weight				
	Scroll	Side sheets	Arr. 1, 8, & 9	Arr. 3	Arr. 1, 8, & 9	Arr. 3		AcoustaFoil		PLR		AcoustaFoil		PLR		
								WR ²	Weight	WR ²	Weight	WR ²	Weight	WR ²	Weight	
18	10	10	1 11/16	-	C	-	10	12	44	11	43	299	-	298	-	
22	10	10	1 15/16	-	C	-	7	26	58	28	63	343	-	348	-	
24	10	10	2 3/16	1 15/16	D	C	7	43	82	46	87	582	677	587	682	
27	10	10	2 3/16	1 15/16	D	C	1/4	65	101	69	103	736	796	738	798	
30	10	10	2 7/16	2 3/16	D	C	1/4	115	131	110	127	1001	1071	997	1067	
33	7	7	2 7/16	2 3/16	D	E	1/4	154	145	155	147	1270	1200	1272	1202	
36	7	7	2 11/16	2 7/16	D	E	1/4	259	258	275	268	1553	1403	1563	1413	
40	7	7	2 15/16	2 11/16	D	E	3/8	407	311	431	325	2051	1711	2065	1725	
44	7	7	2 15/16	2 15/16	D	E	3/8	597	358	628	372	2558	2258	2572	2272	
49	7	7	3 7/16	2 15/16	D	F	3/8	976	558	1059	589	3103	2518	3134	2549	
54	7	7	3 15/16	3 7/16	D	F	3/8	1760	699	2097	796	4169	3369	4266	3466	
60	7	7	4 7/16	3 15/16	D†	F	3/8	2763	855	3188	956	5315	3965	5416	4066	
66	7	7	4 7/16	3 15/16	F*	F	3/8	4160	1061	4938	1210	7051	5901	7200	6050	
73	7	7	4 7/16	4 7/16	F*	F*	3/8	6129	1248	7493	1486	7703	6423	7941	6661	

BEARING TYPES A-Link-Belt P3-U200. D-Sealmaster MPD. E-Link-Belt P-300. F-Link-Belt P-B22400. nyb reserves the right to substitute bearings of equal ratings.
 C-Sealmaster SPM. D†-Sealmaster MSPD. F*-Link-Belt P-B22500.

CLASS 1, 2 ARRANGEMENT 1, 8, 9 DIMENSIONS

SIZES 12 TO 73

SIZES 12 TO 36

SIZES 40 TO 73

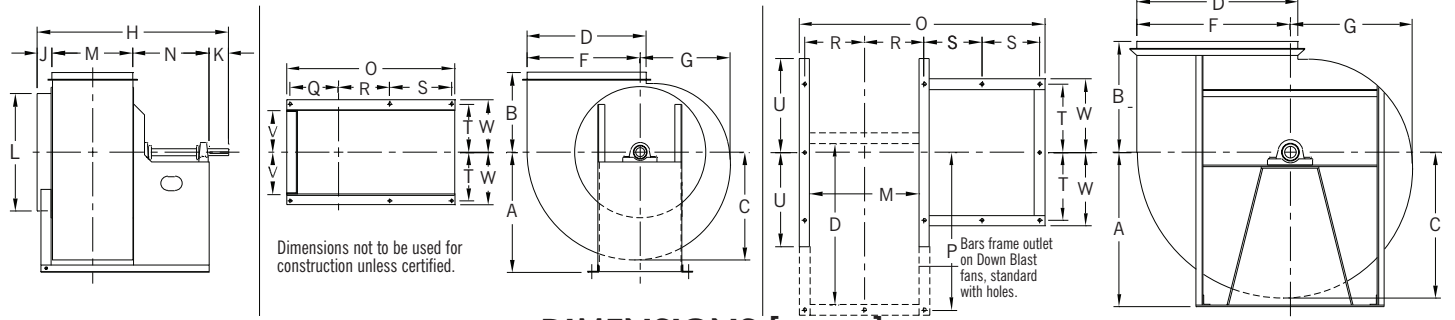

DIMENSIONS [INCHES]

Size	A					B		C	D	F	G	H†		J	K	L	M†	N				O†	P	Q†	R†	S		T	U/W	W	a	b		c	d	Base holes
	TH TAD	BH BAU	UB TAU	DB	*	TAD	Class 1					Class 2	Class 1					Class 2	Class 1	Class 2	Class 1					Class 2	Class 1					Class 2	Class 1			
12	15½	15½	15½	15½	10	10	12¾	13¾	13	10¾	27½	28½	2½	2½	13½	9¾	13½	14½	25	26	6½	6½	107½	117½	7¾	8	11½	16¼	16¼	127½	9¼	9/16				
15	17½	17½	17½	17½	12	12	15½	16¾	15¾	12¾	32	33¾	3½	3	16½	11¾	14½	16¾	28½	29½	7½	7½	117½	135½	87½	8	14½	19¾	19¾	15¾	11¾	9/16				
18	21¼	21¼	21¼	21¼	14	14	18½	20½	19¾	15½	35½	38¾	3½	3½	20	13½	14¾	17½	31½	34¾	8½	9¾	11½	14¾	9¾	8¼	10¼	17¼	23¾	23¾	19½	13¾	9/16			
22	25½	25½	25½	25½	17	17	22½	24¾	23¾	18¾	41¾	45½	3¾	4	24½	16¾	17¾	21½	37½	41¾	10½	11¾	14	17¾	107½	9¾	11¾	21	28¾	28¾	23¼	16¾	9/16			
24	28	28	28	28	19	19	24¾	27¾	26	20¾	45½	50¾	4½	4½	27	18½	18	23¼	39¾	45	11¾	12½	137½	19½	12¼	11	13	23½	317½	317½	255½	18½	¾			
27	30½	30½	30½	30½	20½	20½	27¼	30¼	28½	22½	51	53½	4½	5	30	20¾	21½	24	45½	47¾	12¾	13¾	179½	197½	13¾	11¾	14¾	34¾	34¾	28¾	209½	¾	¾			
30	33¾	33¾	33¾	33¾	22½	22½	30¾	33¾	31½	25¾	53¼	57¾	4½	5½	33	22¾	21½	25½	47¾	51¾	13½	14½	17¾	21¾	13¾	13¾	28¼	38¾	38¾	31¾	225½	¾	¾			
33	37	37	37	37	24½	24½	33¾	36¾	35	28	58¼	63¾	4½	6	36½	24¾	23¼	28¾	51¾	56¾	14¾	15¾	19¾	24½	16	14	17	31½	42½	42½	25¼	¾	¾			
36	42	42	42	42	29	29	36¾	40¾	38¾	30¾	62¼	67¾	5	6½	40	27½	23¼	28¾	54	59¾	15¾	17½	19	24¾	16	14	17	34¾	477½	477½	38¼	27½	¾			
40	46	46	46	46	31	31	40¾	44¾	42¾	34½	73½	74½	5	7	44¾	30¾	30¾	32¼	67½	68¾	16¾	16¾	16¾	19	19	26¼	38	52½	62¼	42½	30	¾	¾			
44	50	50	50	50	33½	33½	45	49¾	47¾	37¾	76¾	81¾	5	7½	49¾	33½	30¾	35¾	75¼	75¼	18¾	18¾	15¾	177½	21	28¾	42	57	68	46½	33¾	¾	¾			
49	55	55	55	55	36	36	49½	54¾	52	41½	82½	85¾	5	8	54¾	36¾	32¼	35¾	75¾	78¾	15¾	20	177½	23	23	31¼	24½	46¾	62¼	74¾	51¼	36½	¾	¾		
54	60½	60½	60½	60½	40	40	58¾	64¾	63¾	49	93¼	101¾	6	9	60½	40¾	33¼	41¾	82	90½	16¾	16¾	207½	25	25	35	27	51½	69	82¾	56¾	41	1	1		
60	66	66	66	66	43	43	64½	70¾	69¾	50½	103¾	108¾	6	9½	67	45	33¼	41¾	86¼	94¼	17¾	24½	21¾	26½	29	29	38½	28½	56¾	75½	90¾	61¾	45¾	1	1	
66	73	73	73	73	47	47	70¼	77¾	76¾	56	103¾	108¾	7	9½	73½	49½	37¾	42¾	97¼	102¼	18¾	21¾	27¼	29	29	42¼	31½	62¼	82¾	99¾	69¾	49¾	1	1		
73	80½	80½	80½	80½	51½	51½	76½	81¼	81¼	61¾	109½	123½	7	10	81½	54¾	37¾	51¾	102½	116½	19¾	29¾	33½	36	36	46¼	36	68¾	91¼	108¾	76¾	55¾	1	1		

*For TH, BH, UB, DB, BAU and TAU discharge. †Dimensions may vary with narrow-width construction. J is from housing side over inlet collar. L, M, and D are outside dimensions. Tolerance: ± 1/8"

CLASS 3 ARRANGEMENT 1, 8, 9 DIMENSIONS

SIZES 18 TO 73

SIZES 18 TO 33

SIZES 36 TO 73

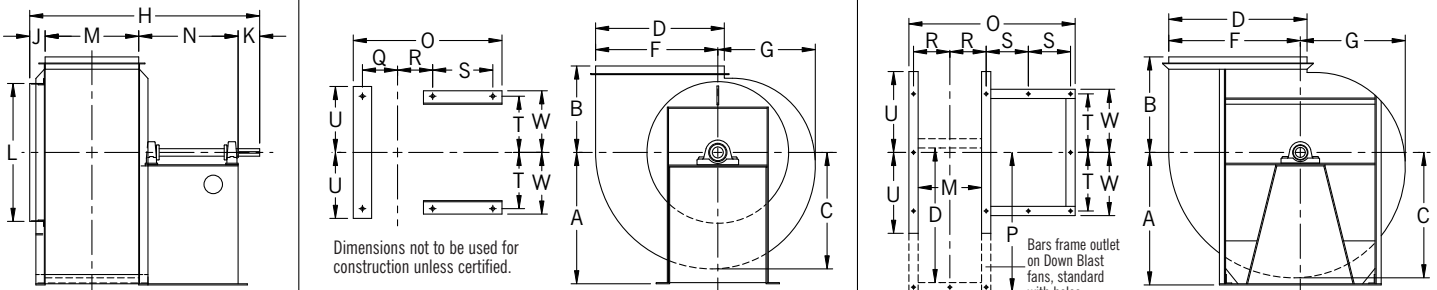

DIMENSIONS [INCHES]

Size	A					B		C	D	F	G	H†	J	K	L	M†	N	O†	P	Q†	R†	S	T	U	W	a	b		c	d	Base holes
	TH TAD	BH BAU	UB TAU	DB	*	TAD	BAU TAU																				TAD				
18	21¾	21¾	21¾	21¾	14	14	18½	20½	19¾	15½	37½	3¾	4	20¾	137½	16½	33¾	8¼	8½	13¾	9¾	107½	10¼	17¼	23¾	23¾	19½	137½	9/16	9/16	
22	26	26	26	26	17	17	22½	24¾	23¾	18¾	45¾	3¾	4½	25½	167½	21¼	41¾	10¼	10	18½	107½	12¾	11¾	21	28¾	28¾	23¼	16¾	9/16	9/16	
24	28½	28½	28½	28½	19	19	24¾	27¾	26	20¾	497½	4½	5	27½	18½	22¼	45	11½	11¾	18½	12¼	14¾	13½	23½	317½	317½	255½	18½	¾	¾	
27	31½	31½	31½	31½	20½	20½	27¼	30¼	28½	22½	53¼	4½	5½	30¼	20¾	23¼	477½	12½	12½	19½	13¾	15½	147½	25¾	34¾	34¾	28¼	209½	¾	¾	
30	34¾	34¾	34¾	34¾	22½	22½	30¾	33¾	31¾	25¾	58¾	4½	6	33¾	22¾	26	527½	13¾	13¾	217½	147½	167½	167½	28¼	38¾	38¾	31¾	225½	¾	¾	
33	37¾	37¾	37¾	37¾	24½	24½	33¾	36¾	35	28	64	4½	6½	36¾	247½	28½	57¾	14¾	14¾	24¾	16	18¼	17¼	31½	42½	42½	34¾	25¼	¾	¾	
36	42	42	42	42	29	29	41¼	45¼	44¾	34½	72½	5	7	41	27½	27	60½	40¼	15¼	13½	17½	24½	19	34¾	477½	57¼	38¼	27½	¾	¾	
40	46	46	46	46	31	31	45¼	49¾	48¾	37¾	79½	5	7½	44¾	30¾	30	66¾	44¼	16¾	15	19	26¼	20½	38	52½	62¼	42½	30	¾	¾	
44	50	50	50	50	33½	33½	49	54	53	41½	86¾	5	8	49¾	33½	33	727½	48¾	18¼	16½	21	28¾	22½	42	57	68	46½	33¾	¾	¾	
49	55	55	55	55	36	36	53¼	49½	54¾	52	86¾	5	8½	54¾	36¾	36	787½	53½	20	18	23	31¼	24½	46¾	62¼	74¾	51¼	36½	¾	¾	
54	60½	60½	60½	60½	40	40	58¾	64¾	63¾	49	95¾	6	9	60¼	40¾	40	88¾	59¾	22¾	20	25	35	27	51½	69	82¾	56¾	41	1	1	
60	66	66	66	66	43	43	64½	70¾	69¾	50½	105½	6	9½	67	45	45	98	65¾	24½	22½	26½	38½	28½	56¾	75½	90¾	61¾	45¾	1	1	
66	73	73	73	73	47	47	70¼	77¾	76¾	56	115½	7	10	73½	49½	49	1087½	72½	27¼	24½	29	42¼	31½	62¼	82¾	99¾	69¾	49¾	1	1	
73	84	84	84	84	51½	51½	76½	81¼	81¼	61¾	126¼	7	10½	81½	54¾	54	118¾	80	297½	27	33½	46¼	36	68¾	91¼	108¾	76¾	55¾	1	1	

*For TH, BH, UB, DB, BAU and TAU discharge. †Dimensions may vary with narrow-width construction. J is from housing side over inlet collar. L, M, and D are outside dimensions. Tolerance: ± 1/8"

CLASS 1, 2, 3 ARRANGEMENT 3 DIMENSIONS

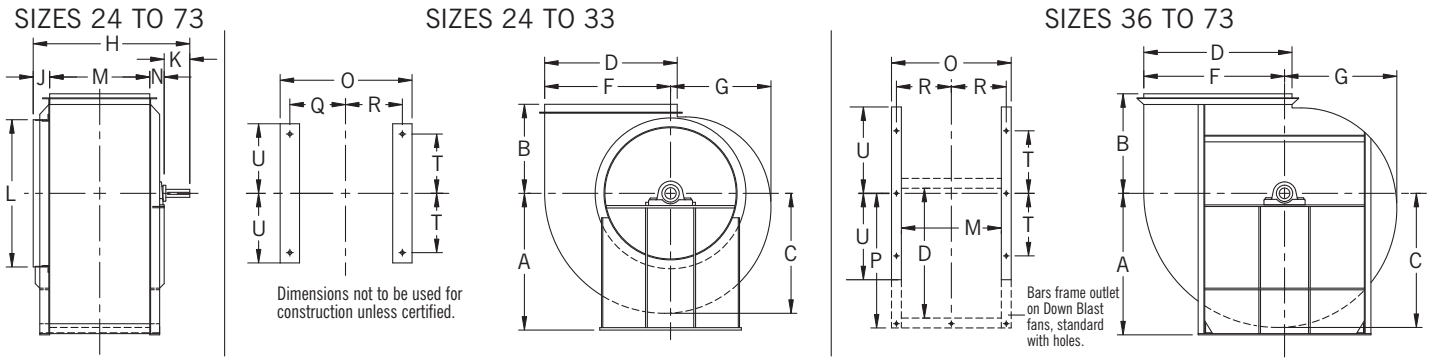

DIMENSIONS [INCHES]

Size	A				B		C	D	F	G	H			J	K	
	TH TAD	BH BAU	UB TAU	DB	*	TAD					Class 1	Class 2	Class 3		Class 1, 2	Class 3
24	28	28	28	28	19	19	24 ³ / ₄	27 ³ / ₈	26	20 ³ / ₄	29 ³ / ₄	29 ³ / ₄	30 ¹ / ₄	4 ¹ / ₈	4 ¹ / ₂	5
27	30 ¹ / ₂	30 ¹ / ₂	30 ¹ / ₂	30 ¹ / ₂	20 ¹ / ₂	20 ¹ / ₂	27 ¹ / ₄	30 ¹ / ₄	28 ⁵ / ₈	22 ⁷ / ₈	32 ¹ / ₈	32 ¹ / ₈	32 ⁵ / ₈	4 ¹ / ₈	5	5 ¹ / ₂
30	33 ³ / ₄	33 ³ / ₄	33 ³ / ₄	33 ³ / ₄	22 ¹ / ₂	22 ¹ / ₂	30 ³ / ₈	33 ¹ / ₂	31 ⁷ / ₈	25 ³ / ₈	34 ⁷ / ₈	34 ⁷ / ₈	35 ⁷ / ₈	4 ¹ / ₈	5 ¹ / ₄	6
33	37	37	37	37	24 ¹ / ₂	24 ¹ / ₂	33 ³ / ₈	36 ⁷ / ₈	35	28	38 ⁵ / ₈	38 ⁵ / ₈	40 ⁵ / ₈	5 ¹ / ₈	5 ³ / ₄	6 ¹ / ₂
36	33	42	39	29	29	41 ³ / ₄	36 ⁷ / ₈	40 ³ / ₄	38 ³ / ₄	30 ⁷ / ₈	43	43	44 ¹ / ₂	6	6 ¹ / ₂	7
40	36	46	43	31	31	45 ¹ / ₄	40 ³ / ₄	44 ⁷ / ₈	42 ³ / ₄	34 ¹ / ₈	47 ³ / ₈	47 ¹ / ₂	49 ⁷ / ₈	7	7	7 ¹ / ₂
44	40	50	47	33 ¹ / ₂	49	33 ¹ / ₂	45	49 ⁵ / ₈	47 ¹ / ₈	37 ³ / ₄	51	53	53 ¹ / ₂	7	7 ¹ / ₂	8
49	43 ¹ / ₂	55	51 ¹ / ₂	36	36	53 ¹ / ₄	49 ¹ / ₂	54 ⁵ / ₈	52	41 ¹ / ₂	55	56 ⁷ / ₈	57 ³ / ₈	7	8	8 ¹ / ₂
54	48	60 ¹ / ₂	57	40	40	58 ³ / ₄	54 ⁷ / ₈	60 ³ / ₈	57 ¹ / ₂	45 ⁷ / ₈	60 ¹ / ₄	61 ¹ / ₄	62	7	8 ¹ / ₂	9
60	53	66 ¹ / ₂	62 ¹ / ₂	43	43	64 ¹ / ₂	60 ³ / ₄	66 ⁷ / ₈	63 ³ / ₄	50 ⁷ / ₈	65	66 ¹ / ₄	67 ¹ / ₈	7	9	9 ¹ / ₂
66	58	73	69	47	47	70 ¹ / ₄	66 ³ / ₄	73 ¹ / ₂	70	56	71	71 ¹ / ₄	72 ¹ / ₈	7	9 ¹ / ₂	10
73	64	80 ¹ / ₂	76	51 ¹ / ₂	51 ¹ / ₂	76 ¹ / ₂	73 ⁷ / ₈	81 ¹ / ₄	77 ¹ / ₂	61 ⁷ / ₈	77	79 ³ / ₈	81 ¹ / ₄	9	10	10 ¹ / ₂

Size	L	M	N			O	P Q	R	T	U	a	b		C	d	Base holes
			Class 1	Class 2	Class 3							BAU TAU	TAD			
24	27 ⁵ / ₈	18 ¹ / ₂	2 ⁵ / ₈	2 ⁵ / ₈	2 ⁵ / ₈	27 ¹ / ₈	11 ¹ / ₂	11 ¹ / ₂	12 ¹ / ₄	14 ³ / ₈	23 ¹ / ₈	31 ⁷ / ₈	31 ⁷ / ₈	25 ⁵ / ₈	18 ¹ / ₂	3/4
27	30 ¹ / ₄	20 ³ / ₈	2 ⁵ / ₈	2 ⁵ / ₈	2 ⁵ / ₈	29	12 ¹ / ₂	12 ¹ / ₂	13 ⁵ / ₈	15 ¹ / ₂	25 ³ / ₈	34 ³ / ₄	34 ³ / ₄	28 ¹ / ₄	20 ³ / ₈	3/4
30	33 ⁵ / ₈	22 ⁵ / ₈	2 ⁷ / ₈	2 ⁷ / ₈	2 ⁷ / ₈	31 ¹ / ₄	13 ⁵ / ₈	13 ⁵ / ₈	14 ⁷ / ₈	16 ⁷ / ₈	28 ¹ / ₄	38 ³ / ₈	38 ³ / ₈	31 ³ / ₈	22 ⁵ / ₈	3/4
33	36 ⁷ / ₈	24 ⁷ / ₈	2 ⁷ / ₈	2 ⁷ / ₈	4 ¹ / ₈	33 ¹ / ₂	14 ³ / ₄	14 ³ / ₄	16	18 ¹ / ₄	31 ¹ / ₈	42 ¹ / ₈	42 ¹ / ₈	34 ⁵ / ₈	25 ¹ / ₄	3/4
36	41	27 ¹ / ₂	3	3	4	33 ¹ / ₂	40 ¹ / ₄	15 ¹ / ₄	17 ¹ / ₂	24 ¹ / ₂	34 ³ / ₈	47 ⁷ / ₈	57 ¹ / ₄	38 ¹ / ₄	27 ¹ / ₂	7/8
40	44 ³ / ₄	30 ³ / ₈	3	3 ¹ / ₈	5	36 ³ / ₈	44 ¹ / ₄	16 ³ / ₄	19	26 ¹ / ₄	38	52 ¹ / ₈	62 ¹ / ₄	42 ¹ / ₈	30	7/8
44	49 ³ / ₄	33 ¹ / ₂	3	5	5	39 ¹ / ₂	48 ⁵ / ₈	18 ¹ / ₄	21	28 ³ / ₄	42	57	68	46 ¹ / ₂	33 ⁵ / ₈	7/8
49	54 ³ / ₄	36 ⁷ / ₈	3 ¹ / ₈	5	5	42 ⁷ / ₈	53 ¹ / ₂	20	23	31 ¹ / ₄	46 ¹ / ₈	62 ¹ / ₄	74 ³ / ₈	51 ¹ / ₄	36 ¹ / ₂	7/8
54	60 ¹ / ₄	40 ³ / ₄	4	5	5 ¹ / ₄	48 ³ / ₄	59 ¹ / ₂	22 ³ / ₈	25	35	51 ¹ / ₈	69	82 ³ / ₈	56 ³ / ₄	41	1
60	67	45	4	5 ¹ / ₄	5 ³ / ₈	53	65 ⁵ / ₈	24 ¹ / ₂	26 ¹ / ₂	38 ¹ / ₂	56 ⁵ / ₈	75 ¹ / ₂	90 ⁵ / ₈	61 ⁷ / ₈	45 ³ / ₈	1
66	73 ¹ / ₂	49 ¹ / ₂	5	5 ¹ / ₄	5 ⁵ / ₈	59 ¹ / ₂	72 ¹ / ₂	27 ¹ / ₄	29	42 ¹ / ₄	62 ¹ / ₄	82 ³ / ₄	99 ¹ / ₈	69 ¹ / ₈	49 ⁷ / ₈	1
73	81 ¹ / ₂	54 ³ / ₄	5 ¹ / ₄	5 ⁵ / ₈	7	64 ³ / ₄	79 ⁷ / ₈	29 ⁷ / ₈	33 ¹ / ₂	46 ¹ / ₄	68 ⁷ / ₈	91 ¹ / ₄	108 ⁷ / ₈	76 ³ / ₈	55 ¹ / ₈	1

*For TH, BH, UB, DB, BAU and TAU discharge. J is from housing side over inlet collar. L, M, and D are outside dimensions. Tolerance: ± 1/8"

FAN DISCHARGES – VIEWED FROM DRIVE SIDE

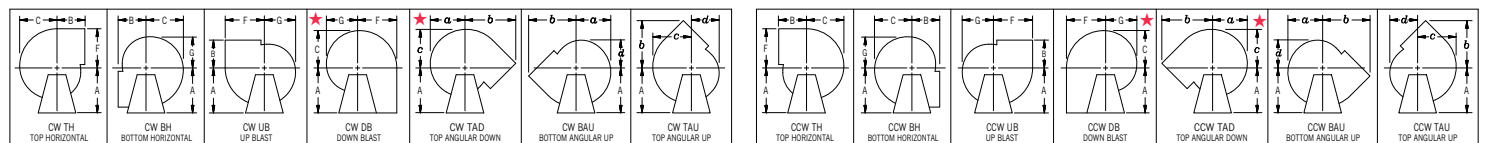

Clockwise—angular discharges at 45°

Counterclockwise—angular discharges at 45°

★ Down Blast and Top Angular Down discharge positions must be evaluated for clearance of accessories such as flanged outlet, outlet damper, unitary base, etc. Consult **nyb** with specific details.

The New York Blower Company has a policy of continuous product development and reserves the right to change designs and specifications without notice.

COMPLETE SELECTION OF AIR-MOVING EQUIPMENT

The New York Blower Company offers thousands of different types, models, and sizes of air-moving equipment. Contact your nyb representative for assistance in identifying the best fan for your application.

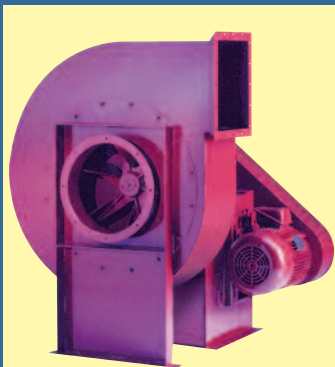

DUST/MATERIAL HANDLING

Wide range of duty available with unique fan lines capable of handling light dust to heavy material. Typical applications include dust-collection and high-pressure process along with material-conveying.

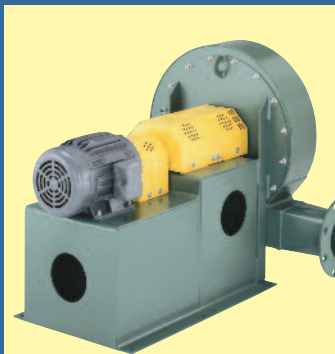

AIR-HANDLING [CENTRIFUGAL]

Designed for clean to moderately dirty gas streams. Commercial and industrial HVAC, process cooling, light material-conveying, heat removal, and dryer exhaust are just a few of the numerous sample applications.



AIR-HANDLING [AXIAL]

For the ideal handling of clean to moderately dirty airstreams. Commercial and industrial HVAC, drying and cooling systems, fume extraction, and process-heat removal are typical applications.



FIBERGLASS REINFORCED PLASTIC [FRP]

Choice of performance and duty for corrosive gas streams. Applications include chemical process, wastewater treatment, laboratory hood exhaust, and tank aeration.

CUSTOM PRODUCTS

Designed for unique applications. Variety of configurations, temperatures, flows, and pressures. Wide range of modifications and accessories are available to meet the most demanding specifications.

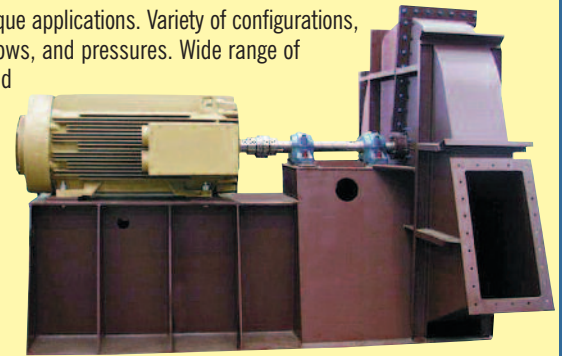

Leading the industry forward since 1889



ROOF VENTILATORS

Including both hooded and upblast ventilators, propeller fans, and centrifugal roof exhausters. These units are ideal for industrial, commercial, and institutional applications.



HEATING PRODUCTS

Industrial-duty steam unit heaters with steam heating coils are available for facility heating and process-heat transfer.

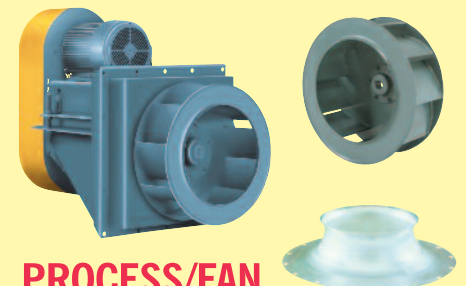

PROCESS/FAN COMPONENTS

Plug fans, plenum fans, wheels, inlet cones, and housings for a wide variety of OEM applications. Process/fan components are used in air-handling units, ovens, dryers, freezer tunnels, and filtration systems.