

HIGH-EFFICIENCY AIRFOIL **AF FANS**

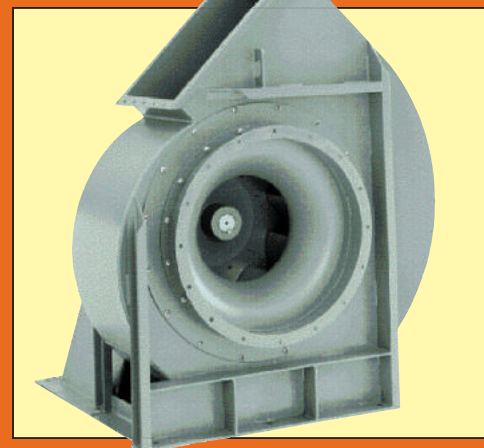

AF-40 FANS

- Capacities to 240,000 CFM
- Static pressures to 46" WG



AF-30 FANS

- Capacities to 123,000 CFM
- Static pressures to 30" WG

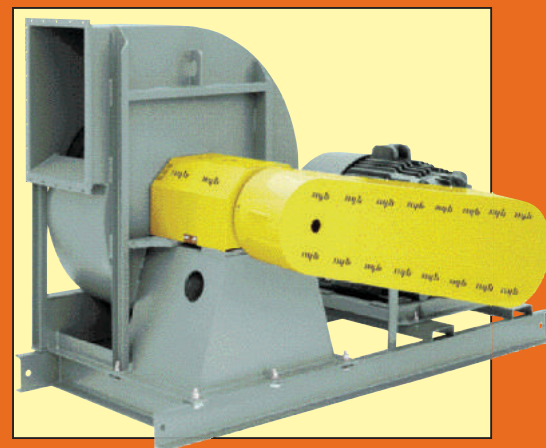

AF-50 FANS

- Capacities to 130,000 CFM
- Static pressures to 50" WG



THE NEW YORK BLOWER COMPANY
7660 Quincy Street
Willowbrook, IL 60527-5530

Visit us on the Web: <http://www.nyb.com>
Phone: (800) 208-7918 Email: nyb@nyb.com

AF FANS

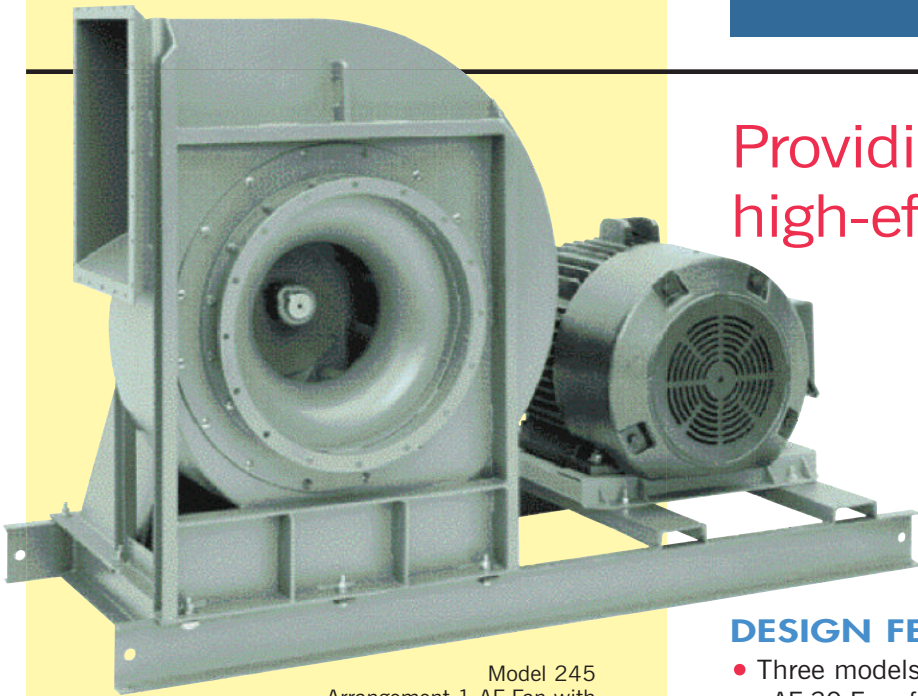

Model 245
Arrangement 1 AF Fan with
unitary base and motor.

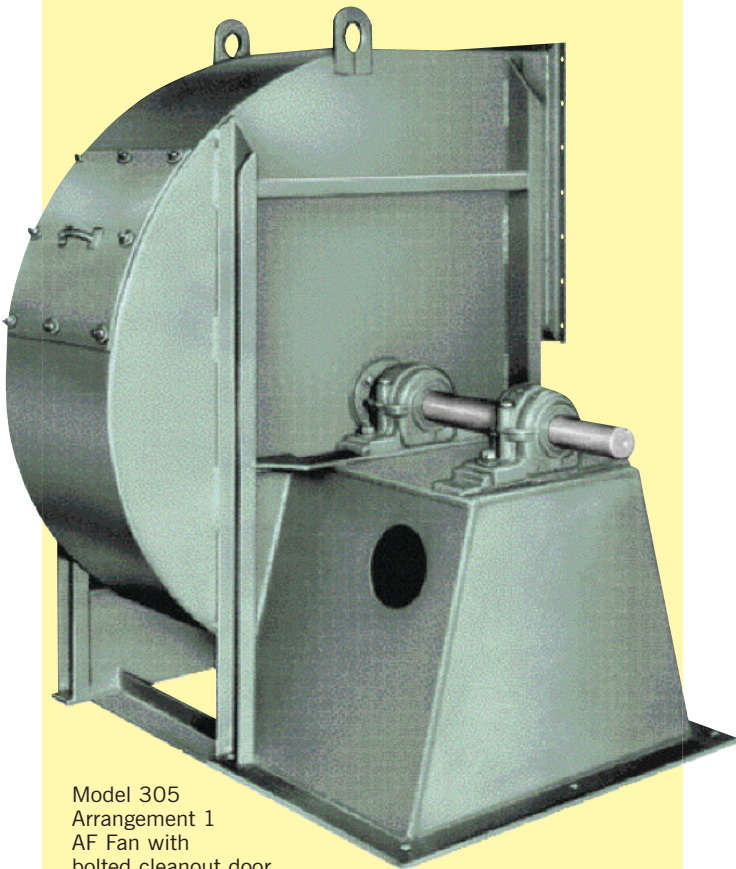

Model 305
Arrangement 1
AF Fan with
bolted cleanout door.

Providing more
high-efficiency choices.

APPLICATIONS

With three designs to choose from, the AF line of fans is ideally suited for a wide range of high-pressure, industrial-process applications including: combustion air, solvent recovery, thermal oxidation, fluidizing, combustion, and air recirculation.

DESIGN FEATURES

- Three models to choose from:
 - AF-30 Fans for applications to 30" WG; wheel dia. 24" to 66".
 - AF-40 Fans for applications to 46" WG; wheel dia. 24" to 80".
 - AF-50 Fans for applications to 50" WG; wheel dia. 24" to 66".
- Direct-drive models to 60" WG.
- Capacities to 240,000 CFM.
- Operating temperatures to 750°F.
- Available in Arrangements 1, 3, 4, 7, and 8.
- Airfoil wheels for static efficiencies to 88%.
- Available in clockwise and counterclockwise rotations in any of seven standard discharge positions.

STANDARD FEATURES

Welded construction—heavy-gauge housing and pedestal. Reinforcements pre-engineered for each model.

Precision balancing—AF wheels are dynamically balanced before final assembly. After assembly, fans are fine-tune balanced at specified operating speed.

Shafting—turned, ground, and polished shafting is straightened to close tolerance to minimize "run-out" and ensure smooth operation.

Bearings—ball or spherical roller bearings selected for each model to provide extended service life.

Flanged inlet and outlet—furnished with bolt holes for ease of installation.

Lifting eyes—sized and located for ease of handling.

Shaft seal—ceramic-felt seals standard on all Arrangement 1 and 8 fans...multiple-seal elements encased between metal backing plate and retainers. Teflon® shaft hole closure standard on Arrangement 4 fans.

[Teflon is a registered trademark of DuPont.]

AF WHEELS

Designed for three levels of high pressure and high-capacity performance.

The AF wheel design has been in production since the 1970s. It has proven itself to be the high-efficiency, high-capacity workhorse of the industry in over 3000 industrial-process applications.

The New York Blower Company has incorporated state-of-the-art finite element analysis modeling, laboratory testing, and the latest alloy technology to the time-tested AF wheel to produce two new cost-effective wheels designed for applications requiring high capacity, high efficiency, and high pressures.

The new AF family of wheels is now capable of cost-effective performance in high-pressure applications from 30"WG of pressure to over 60"WG of pressure at high volumes.

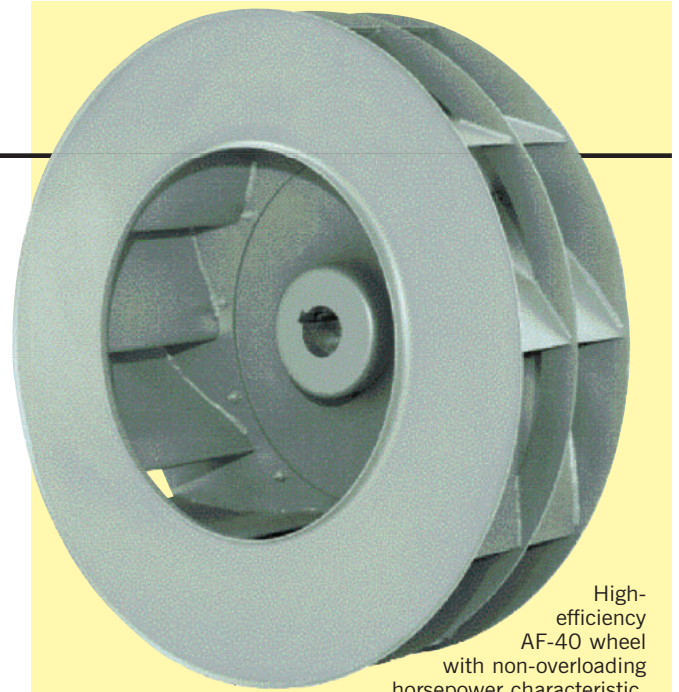

High-efficiency AF-40 wheel with non-overloading horsepower characteristic.

OPTIONAL ST WHEEL

The AF fan lines are also available with single-thickness airfoil ST wheel designs for slightly contaminated gas streams and alternate performance. Contact your **nyb** sales representative for selection assistance.

ARRANGEMENT FLEXIBILITY

ARRANGEMENT

1

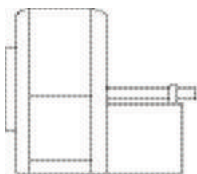

Overhung wheel on shaft-and-bearing assembly isolates fan bearings from airstream. Normally this arrangement is used for V-belt-drive fans which provides flexibility in fan performance.

Maximum temperature:
Standard fan: 300°F.
Heat fan: 750°F.

ARRANGEMENTS

3/7

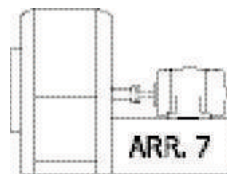

Wheel positioned between bearings...provides physically compact unit. Arrangement 3 fans are usually sold for V-belt-drive fan applications. Arrangement 7 fans include an integral motor base to accommodate motor and coupling.

Maximum temperature: 120°F.

ARRANGEMENT

4

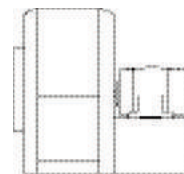

Wheel mounted directly on motor shaft to provide the most compact design. Elimination of shaft and bearings for minimum maintenance. Narrow-width wheel designs permit higher speeds and pressures.

Maximum temperature: 180°F.

ARRANGEMENT

8

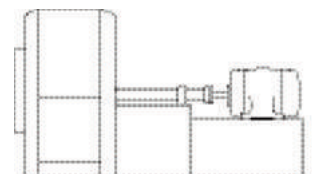

Similar to Arrangement 1 but with integral motor base to accommodate motor and coupling.

Maximum temperature:
Standard fan: 300°F.
Heat fan: 750°F.

ACCESSORIES

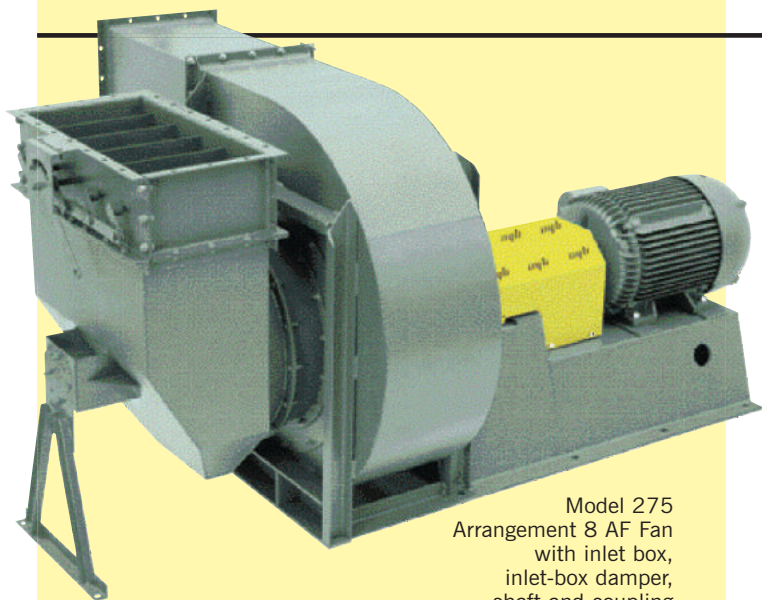

Model 275
Arrangement 8 AF Fan
with inlet box,
inlet-box damper,
shaft and coupling
guard, and motor.

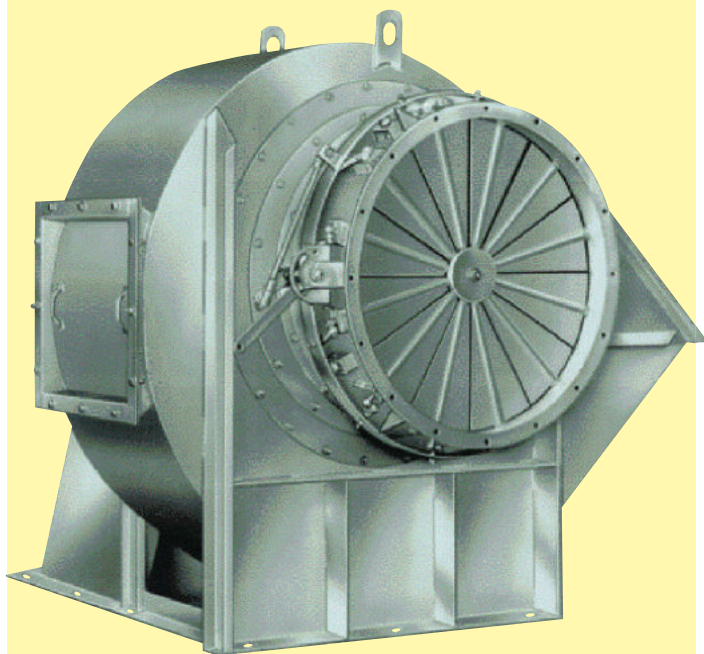

Model 405 Arrangement 1 AF Fan
with external inlet-vane damper and
raised-bolted cleanout door.

- **COMPANION FLANGES**

Designed to fit flush with fan inlet and outlet flanges, provided with a matching hole pattern.

- **EVASE**

Aerodynamically designed evase provides attached flow for maximum static pressure regain and reduced outlet velocities. AF Fans with evases offer static efficiencies to 88%.

- **DRAIN**

Welded tank flange [FPT], 1½" located at the lowest point in the housing scroll.



- **CLEANOUT DOOR**

Two types of gasketed door available...**bolted**: closely spaced studs keep door securely sealed...**raised bolted**: allows for insulation when desired, door raised 2" from the fan housing.

- **INLET BOX**

Minimizes entry losses normally associated with 90° turns at or near fan inlet...also available with parallel-blade damper for efficient volume control.

- **SHAFT SEALS**

Ceramic-felt shaft seals consist of compressed ceramic felt elements standard on Arrangements 1 and 8. Lubricated lip seals [Buna-N, Teflon, and Viton®] and gas-purgeable mechanical seals are also available. See your **nyb** representative for availability. [Viton is a registered trademark of DuPont Dow Elastomers.]

- **INLET DAMPERS**

External vane construction provides prespun air effect to control fan performance efficiently...not available for use with inlet box...maximum temperature: 750°F.

- **OTHER ACCESSORIES**

Also available from **nyb** are drive components such as motors, couplings, and v-belt drives as well as a variety of preventative-maintenance products including vibration detectors, bearing-temperature detectors, and zero-speed switches.

SAFETY EQUIPMENT

Belt guards, inlet and outlet guards, shaft and bearing guards, and coupling guards are available from The New York Blower Company. Contact your **nyb** representative for further information.

NOTE: Safe operation of air-moving equipment is dependent on proper installation and maintenance including selection and use of appropriate safety accessories for the specific installation. The system designer must consider providing guards for all exposed moving parts as well as protection from access to high-velocity airstreams. Improper application, installation, maintenance, or safety-guard selection can create

danger to life and limb of personnel. Users and/or installers should read "Recommended Safety Practices For Air Moving Devices" as published by the Air Movement and Control Association International, 30 West University Drive, Arlington Heights, Illinois 60004, which is included with the packing slips for all shipments from **nyb** and available on request.

MODIFICATIONS

- **HEAT-FAN CONSTRUCTION**

Arrangement 1 and 8 AF Fans are designed to handle airstream temperatures to 300°F.

AF Fans handling 301°F. to 750°F. airstreams are furnished with shaft coolers and shaft cooler guards, and all surfaces are coated with high-temperature paint.

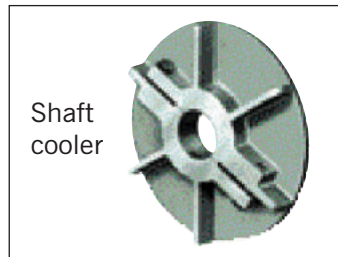

NOTE: Contact nyb when the intended service involves a temperature rate change exceeding 20°F. per minute.

- **OUTLET DAMPERS**

Heavy-gauge parallel-blade or opposed-blade outlet dampers are available for volume control. Two standard temperature ranges: 300°F. and 800°F.

- **SPECIAL ALLOY CONSTRUCTION**

Airstream components can be constructed of a wide range of alternate alloys for corrosive applications including stainless steel and alloy 2205.

- **COATINGS**

Cost-effective protective coatings under a variety of trade names are available to increase the fan's resistance to adverse, corrosive environments.

- **SPLIT-HOUSING CONSTRUCTION**

Provides for wheel and shaft removal...split portion can be removed without disturbing the inlet or outlet connections.

Model 245
Arrangement 8
AF Fan with
evase, shaft
and coupling
guard, and
motor.

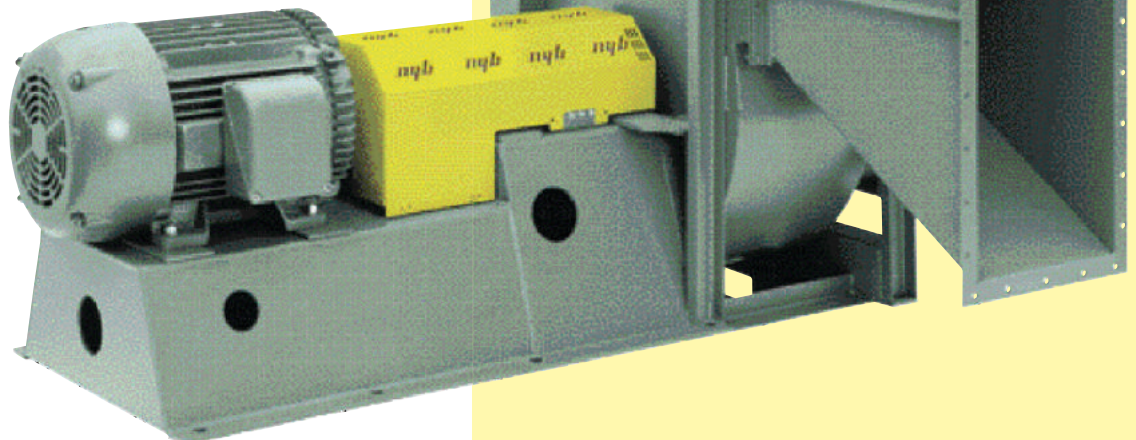

- **VIBRATION ISOLATION**

Rubber-in-shear or spring-type isolation mounted to rugged structural unitary base reduces the transmission of vibration to the mounting structure.

- **UNITARY BASE**

Arrangement 1 fan, motor, and guards can be mounted and shipped on a rugged, structural-steel base. Factory-assembled and run-tested prior to shipment.

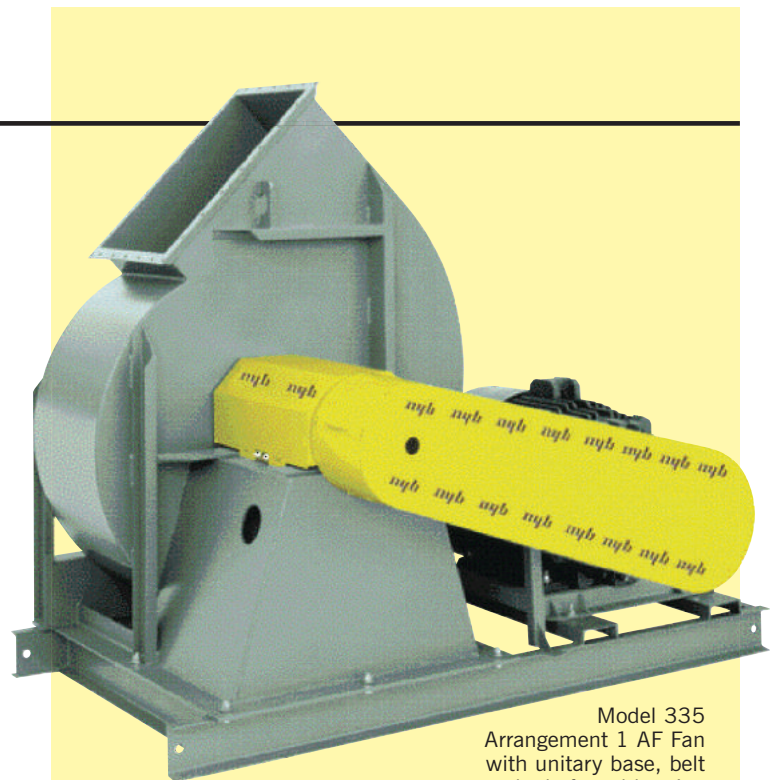

Model 335
Arrangement 1 AF Fan
with unitary base,
belt
guard, shaft and bearing
guard, motor, and drive.

- **NARROW-WIDTH AND OVER-DIAMETER CONSTRUCTION**

Wheel width and diameter can be adjusted to meet volume and pressure requirements at most efficient operating point.

AF FAN ENGINEERING AND SELECTION

GENERAL

Due to the nature of AF Fans and the applications in which they are used, only experienced engineers and systems designers should select AF Fans. It is recommended that selection be made using New York Blower's Electronic Catalog software and that a New York Blower sales representative be consulted for assistance in optimizing the selection.

EVASE

A determination must be made as to whether or not the system discharge duct configuration will allow the use of an energy-saving evase. Depending upon the specific fan size and point of operation, an evase can significantly increase fan efficiency. Performance curves and specific performance data are available by using the Electronic Catalog.

CORRECTION FACTORS

Fan performance is based on actual cubic feet per minute [ACFM] at the fan inlet at standard density [.075 lbs./ft.³] and static pressure at the fan outlet. Static pressure capabilities are shown in inches water gauge ["WG].

Air-density corrections are necessary for proper selection when air density varies from the standard .075 lbs./ft.³ at 70°F. at sea level. This also occurs when negative static pressure exists [rarefaction] on the inlet side of the fan. Multiply the required static pressure at operating conditions by the appropriate factors in Charts I, II, and III to obtain the corrected static pressure for standard conditions. Pressure and BHP will be reduced at conditions by the inverse of these factors. Multiply one factor by the other if temperature, altitude, and rarefaction are non-standard. For example: if the installation is located at an altitude of 4000 feet, the gas temperature is 300°F. and the inlet pressure is -40"WG, the correction factor is 1.84 [1.16 x 1.43 x 1.11].

CHART I ALTITUDE [ft.] CORRECTIONS	
Alt.	Factor
0	1.00
500	1.02
1000	1.04
1500	1.06
2000	1.08
2500	1.10
3000	1.12
3500	1.14
4000	1.16
4500	1.18
5000	1.20
5500	1.23
6000	1.25
7000	1.30
8000	1.35
9000	1.40
10000	1.45

CHART II TEMPERATURE CORRECTIONS	
Temp. °F.	Factor
0	.87
20	.91
40	.94
60	.98
70	1.00
80	1.02
100	1.06
120	1.09
140	1.13
160	1.17
180	1.21
200	1.25
300	1.43
400	1.62
500	1.81
600	2.00
750	2.28

CHART III RAREFICATION CORRECTIONS	
Neg. inlet pressure "WG	Factor
15	1.04
20	1.05
25	1.07
30	1.08
35	1.09
40	1.11
45	1.12
50	1.14
55	1.16
60	1.17
65	1.19
70	1.21
75	1.23
80	1.25
85	1.26

FAN ARRANGEMENT

The choice of a fan arrangement must be made to determine specific fan capabilities. Space availability, airstream temperature, maintenance, control methods, performance requirements, and past practice must all be considered in the selection of fan arrangement. See pages 7 and 10 for further information on arrangements.

HEAT FANS

Fans handling hot airstreams must be kept in operation after system shutdown, until the airstream cools below 200°F. to prevent damage to the fan. The fan wheel or shaft might otherwise distort due to "heat-soaking". The shaft cooler on heat fans is only effective while rotating. Contact **nyb** when the application involves temperature changes greater than 20°F. per minute.

Refer to the selection example on page 10 for the effect of temperature on the maximum safe speed of wheels and the temperature derate factors in Chart V.

Pages 7 and 10 list the temperature limits by fan arrangement.

CHART IV MAXIMUM WHEEL OPERATING SPEEDS [RPM] AT 100% WIDTH			
Model	AF-30	AF-40	AF-50
245	3300	4000	4250
275	3000	3680	3900
305	2700	3310	3550
335	2500	3020	3205
365	2250	2720	2900
405	2035	2470	2640
445	1850	2230	2400
495	1675	2025	2170
545	1500	1830	1970
605	1375	1655	1780
665	1250	1505	1605
735	—	1360	—
805	—	1230	—

CHART V TEMPERATURE DERATES FOR STANDARD AF WHEELS			
Temp. °F.	AF-30	AF-40	AF-50
70	1.00	1.00	1.00
120	0.97	0.99	0.99
200	0.95	0.97	0.97
300	0.92	0.95	0.94
400	0.89	0.92	0.91
500	0.86	0.89	0.88
600	0.83	0.86	0.85
700	0.79	0.84	0.81
750	0.78	0.82	0.80

DIRECT-DRIVE FAN SELECTIONS

It is often more cost-effective to use direct-drive fans due to reduced bearing loads and maintenance. However, a major objection to direct-drive arrangements in the past was the inability to adjust fan speed if system requirements changed. With the advent of variable frequency drives [VFD] the speed and therefore performance of direct-drive fans can now be adjusted to meet varying process requirements.

CHART VI DIRECT-DRIVE UNIT SAFE SPEEDS [RPM]									
Model	AF-30			AF-40			AF-50		
	Arr. 4	Arr. 7	Arr. 8	Arr. 4	Arr. 7	Arr. 8	Arr. 4	Arr. 8 Grease	Arr. 8 Oil
245	3550*	—	3550*	3550	—	3550	3550	3550	—
275	3550*	—	3550*	3550	—	3550	3550	3550	—
305	3550*	—	3550*	3550*	—	3550*	3550	3550	—
335	3550*	—	2500	3550*	—	3550*	3550*	3550*	—
365	3140*	—	2250	3140*	—	2720	3140*	2900	—
405	2850*	2035	2035	2850*	2470	2470	2850*	2640	—
445	2600*	1850	1850	2600*	2230	1950	2600*	2000	2400
495	2340*	1770*	1770*	2340*	2000	2000	2340*	2000	2170
545	—	1770*	1770*	—	1830	1770	—	1770	1950
605	—	1375	1375	—	1770*	1500	—	1770	—
665	—	1200	1200	—	1505	1390	—	1500	1605
735	—	—	—	—	1360	1360	—	—	—
805	—	—	—	—	1230	1230	—	—	—

* Requires narrow-width wheel construction.

ARRANGEMENT 7 AND 8 FANS	The shafts and bearings for Arrangement 7 and 8 AF Fans have been pre-engineered to simplify selection and provide best value. The maximum temperature for Arrangement 7 fans is 120°F. The standard Arrangement 8 fan temperature limit is 300°F. with a high heat option to 750°F. Available in 24" to 80" wheel diameters.
ARRANGEMENT 4 FANS	With the fan wheel directly mounted on the motor shaft, speed limitations imposed by the fan's shaft and bearings are eliminated. In addition, fan maintenance is further reduced by the elimination of these components. The maximum temperature for Arrangement 4 fans is 180°F. Available in 24" to 49" wheel diameters.
WHEEL SPEED VS. WIDTH	A major component in the determination of wheel maximum safe speed is blade strength. Narrower wheels are inherently stronger permitting higher wheel maximum safe speeds. The direct-drive performance curves shown on pages 8 and 9 illustrate maximum performance capabilities with full-width wheels [solid lines] and maximum performance capabilities with narrow-width wheels [dotted lines] at 70°F. Final selection of direct-drive AF Fans can only be optimized using nyb Electronic Catalog software.
PRELIMINARY FAN SELECTION	Following the engineering and selection guidelines presented on page 6 use the corrected capacity [CFM] and pressure ["WG] to determine which AF Fan sizes and models can meet the performance requirements. The direct-drive performance curves on pages 8 and 9 illustrate maximum pressures and capacities at 70°F. Any performance point under the curves can be attained by using a VFD and reducing RPM. Generally the smallest size and lowest model [AF-30, AF-40, AF-50] will be the least expensive; however, a larger size will generally be more efficient requiring a less expensive motor and controls as well as offer significant operating cost savings. To determine the optimum fan at a specific point of operation, nyb Electronic Catalog software must be used [see description below]. To obtain a copy contact your New York Blower sales representative or nyb at www.nyb.com .



ELECTRONIC CATALOG

Fan-selection program corrects for altitude, temperature, rarefaction, adjusts maximum safe speed for wheel width, and generates performance curves. Also includes complete product literature, guide specifications, installation and maintenance literature, Engineering Letters, web-site launch, and a listing of New York Blower sales representatives.

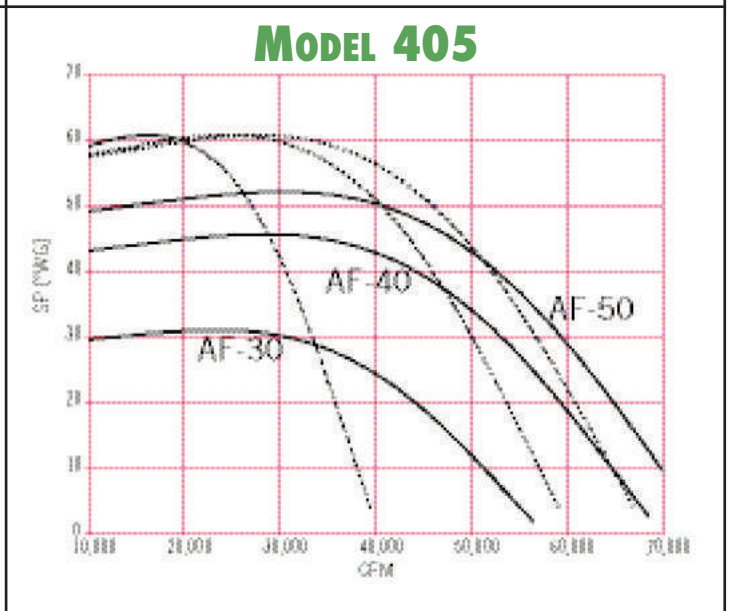
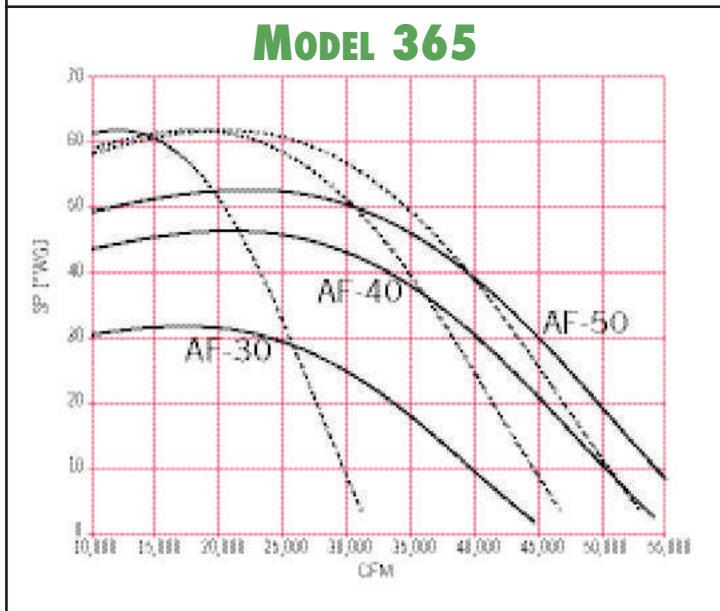
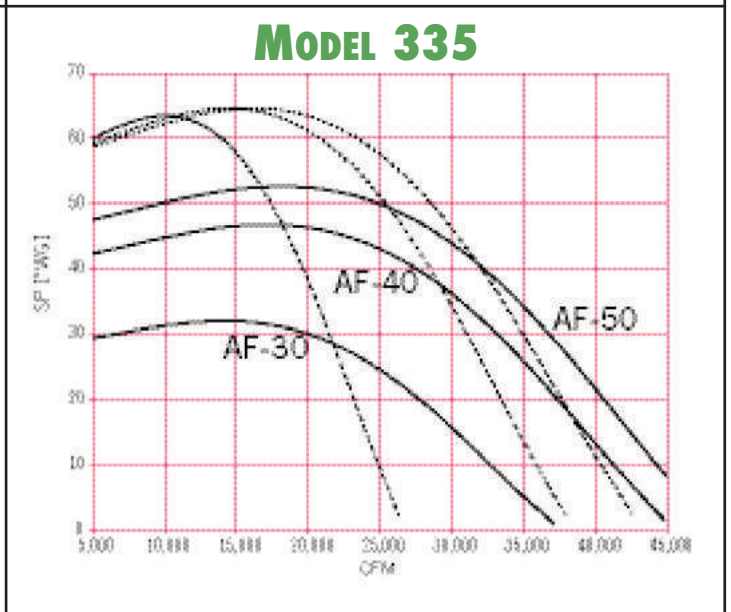
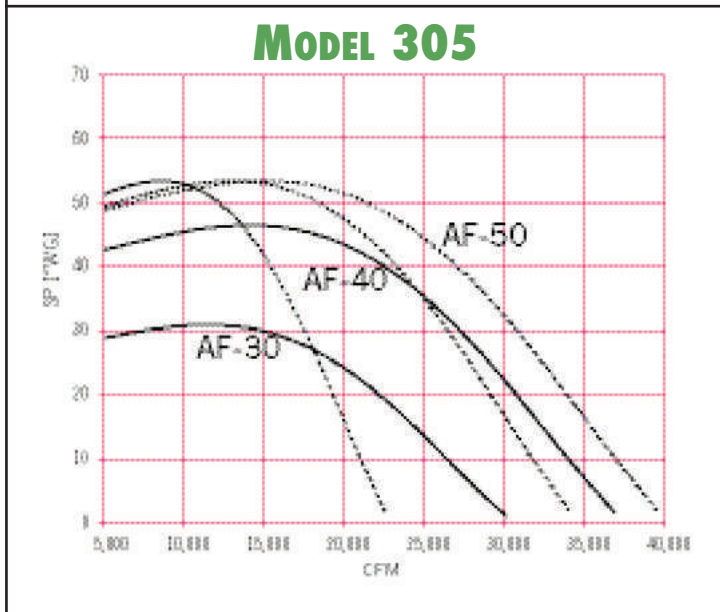
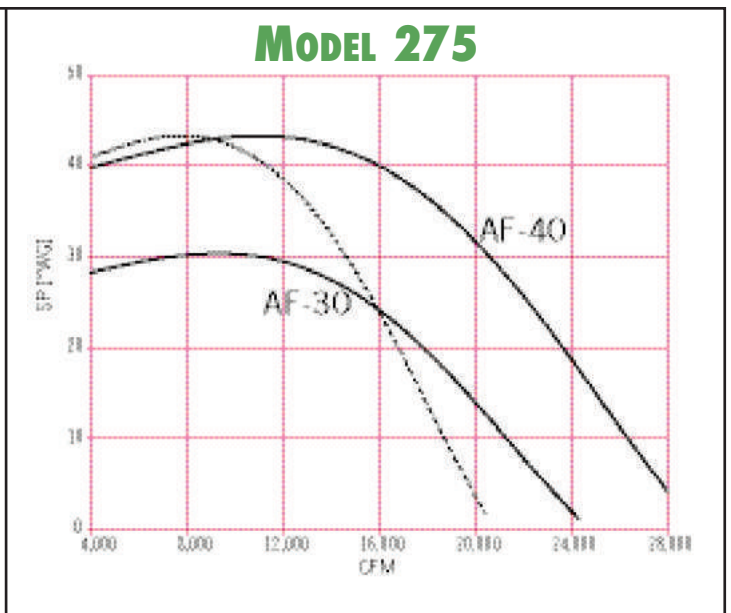
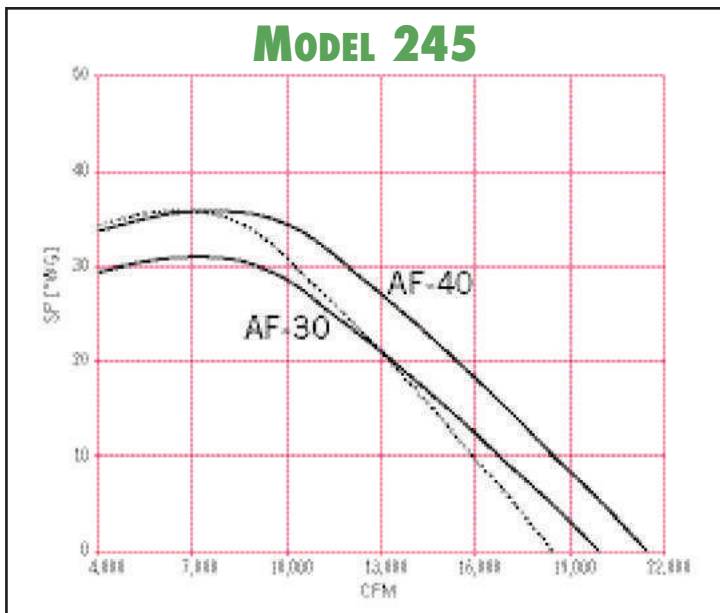

Solid lines are full-width wheels at maximum safe speeds at 70°F. up to nominal motor speed [3550 RPM].
 Dotted lines are narrow-width wheels at maximum safe speeds at 70°F. up to nominal motor speed [3550 RPM].
 Direct-drive curves are based on fan performance without evade.

MODEL 445

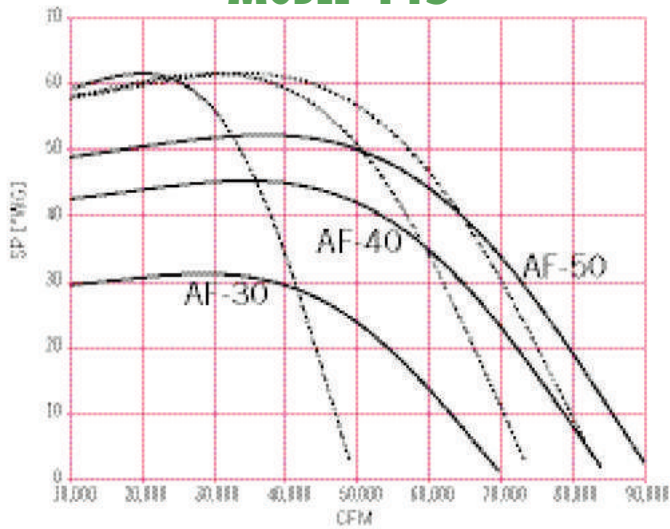

MODEL 495

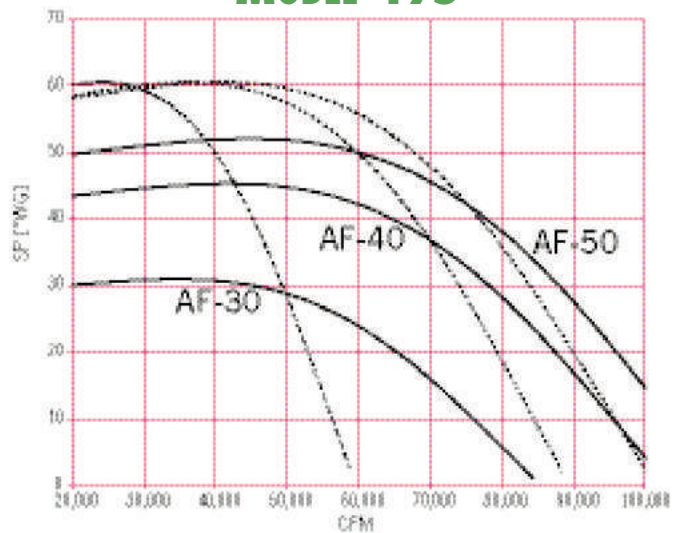

MODEL 545

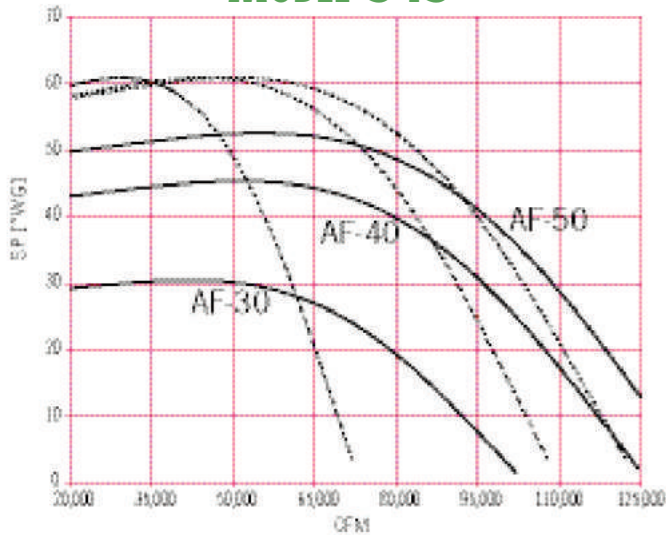

MODEL 605

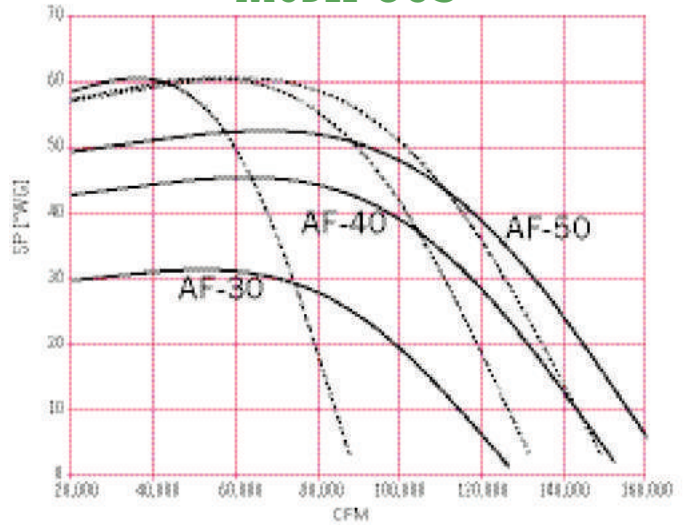

MODEL 665

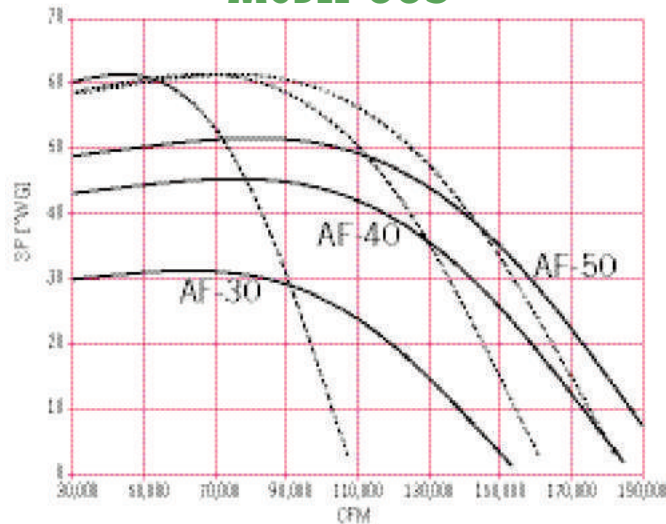

MODEL 735/805 AF-40

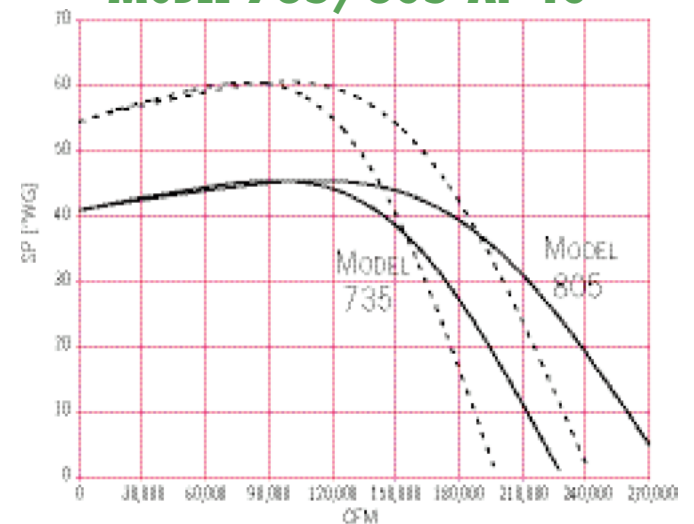

Solid lines are full-width wheels at maximum safe speeds at 70°F. up to nominal motor speed [3550 RPM].
Dotted lines are narrow-width wheels at maximum safe speeds at 70°F. up to nominal motor speed [3550 RPM].
Direct-drive curves are based on fan performance without evase.

BELT-DRIVE FAN SELECTIONS

The use of belt-drive arrangements provides flexibility in fan performance by changing sheaves and belts to modify fan speed.

The high speeds and horsepower requirements of AF Fans require proper drive selection to minimize shaft stress and maximize belt and bearing life. To ensure satisfactory motor performance, 1800 RPM motors 250 HP and above require motor-vendor approval of drive selection.

Arrangement 1 fans—overhung wheel keeps bearings out of airstream. Temperature limit for standard fan is 300°F., optional high-heat construction suitable to 750°F. Note: belt-drive fans are available in 24" to 66" wheel diameters.

Arrangement 3 fans—wheel between bearings provides most compact belt-drive configuration. Maximum temperature is 120°F.



Model 245 Arrangement 1 AF Fan with unitary base, belt guard, shaft and bearing guard, motor, and drive.

HOW TO SELECT A BELT-DRIVE FAN

PROCEDURES	STEPS	EXAMPLE
For a given CFM and static pressure, capacity tables can be used to obtain fan size, outlet velocity, wheel RPM, and BHP. If capacities are at conditions other than 70°F., sea level, or standard density [.075 lbs./cu.ft.], correction factors must be applied to static pressure and BHP.	1	Fan required for 25,000 CFM, 33.2"SP at 120°F., and sea level. The system has 20" negative pressure at the fan inlet. The system allows for use of an evase outlet. The fan is to be Arrangement 1, belt-drive.
If temperature, altitude, or density-rarefaction corrections are required, determine the correction factor using Charts I, II, and III from page 6.	2	Correction factor for 120°F. is 1.09 from Chart II. Correction factor for rarefaction of 20" from Chart III is 1.05. The combined factor 1.09 x 1.05 = 1.145.
Multiply the required operating SP by the correction factor[s]. This gives the equivalent SP at .075 lb./cu.ft. density.	3	The required fan SP at standard air is 33.2 x 1.145 = 38.0 at 0.75 lb./cu. ft.
Select the fan size, RPM, and BHP from the capacity tables. Note: For a given performance, larger fans are generally more efficient and will have lower operating cost over the life of the fan.	4	A Model 335 AF Fan with evase is selected for 25,000 CFM, at 38.0"SP, 2808 RPM, 180 BHP at [standard air] .075 lbs./cu.ft. density.
Determine the maximum safe speed of the fan at operating [or design] temperature from Charts IV and V on page 6.	5	From Chart IV on page 6, the maximum safe speed is 3020 RPM for an AF-40 Fan at 70°F. The correction factor from Chart V for 120°F. is .99, when multiplied by 3020 gives 2990 RPM at 120°F. The fan is satisfactory for operation at 120°F.
Determine operating BHP by dividing the BHP from the capacity tables by the correction factor[s] used in step 3.	6	The fan-operating BHP is 180 divided by the combined correction factor. 180 ÷ 1.145 = 157 BHP.
Confirm maximum unit safe speed for the fan model and arrangement from Chart VII.	7	From Chart VII the Arrangement 1 maximum unit safe speed for a Model 335 AF-40 Fan is 2830 RPM...satisfactory for operation at 2808 RPM.

LEGEND

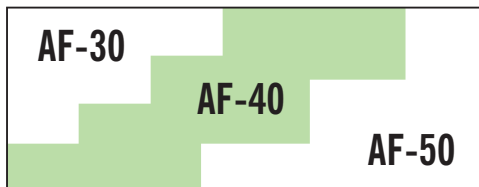

In capacity tables, pages 11 through 16, AF-30 is to the left of the shaded area, AF-40 is shaded area, AF-50 is to the right of the shaded area.

Make sure to review additional speed limitations by arrangement.

CHART VII

BELT-DRIVE UNIT SAFE SPEEDS [RPM]

Model	AF-30		AF-40			AF-50		
	Arr. 1	Arr. 3	Arr. 1		Arr. 3	Arr. 1		Arr. 3
			Grease	Oil†		Grease	Oil†	
245	3300	3300	3800	4000	3800	4250	—	4250
275	3000	3000	3200	3500	3680	3900	—	3900
305	2700	2700	3000	3250	3200	3550	—	3550
335	2500	2500	2830	—	3000	3205	—	3205
365	2250	2250	2200	2720	2720	2900	—	2900
405	2035	2035	2200	—	2200	2000	2500	2640
445	1850	1850	2000	2230	2200	—	—	—
495	1675	1675	1950	—	2000	—	—	—
545	1500	1500	1690	—	1830	—	—	—
605	1375	1375	1655	—	1655	—	—	—
665	1250	1250	1500	—	1505	—	—	—

† Oil lubrication. All others are with grease lubrication.

MODEL 245		WITH EVASE				Wheel diameter: 24.5" Wheel circumference: 6.41'				Outlet area: 3.68 sq. ft. Maximum BHP = 1.86 $\left(\frac{\text{RPM}}{1000}\right)^3$				AF-30 = 3300 RPM AF-40 = 4000 RPM AF-50 = 4250 RPM									
CFM	OV	18"SP		22"SP		26"SP		28"SP		30"SP		34"SP		38"SP		42"SP		46"SP		48"SP		50"SP	
		RPM	BHP	RPM	BHP	RPM	BHP	RPM	BHP	RPM	BHP	RPM	BHP	RPM	BHP	RPM	BHP	RPM	BHP	RPM	BHP	RPM	BHP
8000	2177	2623	29.2	2851	36.1	3058	43.1	3167	47.1	3260	50.6	3465	59.0	3650	67.2	3840	76.4	4014	85.3	4097	95.2	4197	101
9000	2449	2689	32.7	2909	40.1	3110	47.6	3217	51.9	3310	55.7	3488	63.6	3674	72.4	3853	81.5	4017	90.6	4130	102	4203	107
10000	2721	2782	37.1	2983	44.7	3174	52.4	3270	56.6	3362	60.8	3541	69.5	3718	78.6	3888	87.9	4046	97.1	4130	102	4203	107
11000	2993	2877	41.7	3071	49.9	3254	58.2	3341	62.3	3434	66.9	3606	75.9	3776	85.4	3928	94.5	4093	105	4168	110	4246	115
12000	3265	2981	46.7	3163	55.4	3340	64.3	3428	68.9	3506	73.1	3672	82.4	3835	92.2	3993	102	4142	113	4221	118		
13000	3537	3087	52.1	3265	61.4	3438	71.1	3521	75.9	3600	80.6	3762	90.6	3913	100	4058	110	4204	121				
14000	3810	3201	58.0	3371	67.7	3533	77.7	3611	82.7	3692	88.0	3850	98.8	3990	109	4140	120						
15000	4082	3323	64.7	3485	74.9	3639	85.2	3719	90.8	3788	95.8	3943	107	4081	118	4221	129						
16000	4354	3443	71.6	3602	82.5	3755	93.6	3824	98.9	3896	105	4048	117	4184	128								
17000	4626	3579	80.1	3722	90.8	3867	102	3944	108	4012	114	4143	126										

MODEL 275		WITH EVASE				Wheel diameter: 27.0" Wheel circumference: 7.07'				Outlet area: 4.60 sq. ft. Maximum BHP = 3.22 $\left(\frac{\text{RPM}}{1000}\right)^3$				AF-30 = 3000 RPM AF-40 = 3680 RPM AF-50 = 3900 RPM									
CFM	OV	18"SP		22"SP		26"SP		28"SP		30"SP		34"SP		38"SP		42"SP		46"SP		48"SP		50"SP	
		RPM	BHP	RPM	BHP	RPM	BHP	RPM	BHP	RPM	BHP	RPM	BHP	RPM	BHP	RPM	BHP	RPM	BHP	RPM	BHP	RPM	BHP
10000	2174	2291	34.2	2504	42.7	2706	51.4	2809	56.3	2900	60.7												
11500	2500	2358	39.1	2551	48.0	2739	57.3	2827	62.0	2921	67.1	3098	77.5	3277	88.6	3440	99.5	3593	110	3675	117	3761	123
13000	2826	2452	45.0	2627	54.3	2795	63.9	2879	69.0	2954	73.7	3124	84.7	3286	95.9	3445	107	3597	119	3678	126	3751	132
14500	3152	2568	52.0	2721	61.4	2874	71.5	2950	76.8	3024	82.0	3176	93.1	3327	105	3475	117	3616	129	3697	136	3760	142
16000	3478	2694	59.8	2833	69.8	2976	80.5	3047	86.1	3109	91.0	3254	103	3383	114	3522	127	3656	139	3727	146	3801	153
17500	3804	2830	68.8	2958	79.2	3093	90.8	3154	96.2	3217	102	3345	114	3471	126	3598	139	3720	151	3784	158	3850	165
19000	4130	2975	79.1	3098	90.5	3217	102	3280	108	3335	114	3449	126	3571	139	3689	152	3801	165	3859	172		
20500	4457	3129	91.0	3240	103	3349	114	3409	121	3460	127	3574	140	3683	153	3793	167	3896	180				
22000	4783	3284	104	3387	116	3497	129	3544	135	3598	142	3706	156	3804	169								
23500	5109	3441	118	3545	131	3641	144	3691	151	3743	158	3840	172										

MODEL 305		WITH EVASE				Wheel diameter: 30.0" Wheel circumference: 7.85'				Outlet area: 5.62 sq. ft. Maximum BHP = 5.46 $\left(\frac{\text{RPM}}{1000}\right)^3$				AF-30 = 2700 RPM AF-40 = 3310 RPM AF-50 = 3550 RPM									
CFM	OV	18"SP		22"SP		26"SP		28"SP		30"SP		34"SP		38"SP		42"SP		46"SP		48"SP		50"SP	
		RPM	BHP	RPM	BHP	RPM	BHP	RPM	BHP	RPM	BHP	RPM	BHP	RPM	BHP	RPM	BHP	RPM	BHP	RPM	BHP	RPM	BHP
12000	2135	2051	41.2	2247	51.4	2434	62.1	2521	67.5	2614	73.6	2779	85.0										
14000	2491	2112	47.6	2282	58.1	2452	69.4	2539	75.6	2617	81.3	2788	94.5	2942	107	3091	121	3231	134	3306	141		
16000	2847	2208	55.6	2356	66.6	2507	78.4	2584	84.7	2658	90.9	2805	104	2951	118	3095	132	3233	146	3307	154	3373	161
18000	3203	2317	64.7	2456	76.7	2589	88.9	2658	95.5	2725	102	2862	116	2991	130	3124	144	3252	159	3325	168	3381	175
20000	3559	2448	75.8	2571	88.3	2691	101	2755	108	2816	115	2942	130	3059	144	3178	159	3291	173	3355	182	3422	191
22000	3915	2582	88.0	2696	101	2810	115	2870	123	2923	130	3034	144	3142	159	3257	176	3367	192	3425	200	3469	207
24000	4270	2729	103	2835	117	2940	131	2993	139	3043	146	3147	162	3248	178	3349	194	3451	210	3497	218		
26000	4626	2876	118	2979	134	3076	149	3122	157	3169	164	3269	181	3364	198	3453	214	3547	231				
28000	4982	3032	137	3124	152	3218	169	3262	177	3308	185	3398	202	3488	220								
30000	5338	3182	156	3275	173	3366	191	3408	200	3452	209	3534	226										

MODEL 335		WITH EVASE				Wheel diameter: 33.0" Wheel circumference: 8.64'				Outlet area: 6.83 sq. ft. Maximum BHP = 8.79 $\left(\frac{\text{RPM}}{1000}\right)^3$				AF-30 = 2500 RPM AF-40 = 3020 RPM AF-50 = 3205 RPM									
CFM	OV	18"SP		22"SP		26"SP		28"SP		30"SP		34"SP		38"SP		42"SP		46"SP		48"SP		50"SP	
		RPM	BHP	RPM	BHP	RPM	BHP	RPM	BHP	RPM	BHP	RPM	BHP	RPM	BHP	RPM	BHP	RPM	BHP	RPM	BHP	RPM	BHP
15000	2196	1882	51.7	2056	64.4	2228	78.4	2305	85.1	2388	92.6	2533	107.0										
17000	2489	1927	57.9	2087	71.2	2244	85.4	2317	92.5	2396	100.0	2545	116.0	2685	132	2822	149	2950	166				
19000	2782	1994	65.6	2137	79.2	2278	93.6	2349	101.0	2426	110.0	2565	126	2696	142	2823	159	2954	178	3013	186	3075	196
21000	3075	2067	73.8	2200	88.3	2331	103.0	2397	111.0	2466	120	2591	136	2715	153	2844	172	2967	190	3020	199	3084	209
23000	3367	2157	84.0	2281	99.1	2399	115	2461	123	2520	131	2641	148	2760	166	2870	184	2989	204	3052	214	3101	223
25000	3660	2253	95.1	2368	111	2476	127	2534	136	2584	143	2703	162	2808	180	2922	200	3031	219	3081	229	3133	239
27000	3953	2356	108	2460	124	2565	141	2616	150	2668	159	2770	177	2869	195	2975	215	3076	235	3129	246	3184	257
29000	4246	2465	122	2559	139	2656	156	2705	165	2751	174	2848	193	2941	212	3041	233	3135	253	3185	264		
31000	4539	2576	138	2664	155	2754	173	2801	183	2846	192	2934	211	3023	231	3118	253						
33000	4832	2692	156	2775	174	2863	193	2905	203	2948	213	3029	232	3115	253	3200	274						

Performance shown is for AF Fans with evase discharges, with outlet ducts, and with or without inlet ducts. BHP does not include belt losses.

MODEL 365		WITH EVASE				Wheel diameter: 36.5" Wheel circumference: 9.56'				Outlet area: 8.41 sq. ft. Maximum BHP = 14.5 $\left(\frac{\text{RPM}}{1000}\right)^3$			AF-30 = 2250 RPM AF-40 = 2720 RPM AF-50 = 2900 RPM										
CFM	OV	18"SP		22"SP		26"SP		28"SP		30"SP		34"SP		38"SP		42"SP		46"SP		48"SP		50"SP	
		RPM	BHP	RPM	BHP	RPM	BHP	RPM	BHP	RPM	BHP	RPM	BHP	RPM	BHP	RPM	BHP	RPM	BHP	RPM	BHP	RPM	BHP
18000	2140	1696	62.0	1851	76.9	2000	92.9	2076	102	2150	110	2284	128	2422	159	2548	180	2665	200				
20500	2438	1741	70.2	1885	86.1	2029	103	2095	112	2159	121	2291	139	2428	171	2545	192	2666	214	2715	224	2777	237
23000	2735	1802	79.8	1930	96.1	2060	114	2125	123	2189	133	2305	151	2428	171	2545	192	2666	214				
25500	3032	1876	91.1	1993	108	2114	127	2168	136	2226	145	2345	166	2455	186	2568	208	2675	230	2728	241	2782	253
28000	3329	1959	104	2066	122	2176	141	2227	150	2281	160	2391	182	2499	204	2596	224	2700	247	2747	258	2804	272
30500	3627	2046	118	2146	137	2246	156	2300	167	2346	177	2449	199	2550	222	2639	243	2735	266	2793	281	2838	292
33000	3924	2137	133	2235	154	2332	175	2379	186	2423	196	2517	219	2612	243	2696	264	2785	288	2839	303	2881	315
35500	4221	2237	151	2329	173	2415	194	2461	206	2504	217	2588	239	2679	264	2764	289	2849	314	2887	325		
38000	4518	2338	171	2425	194	2505	216	2549	228	2591	240	2673	264	2755	289	2836	314						
40500	4816	2440	192	2522	216	2601	240	2644	253	2680	265	2760	290	2834	315								

MODEL 405		WITH EVASE				Wheel diameter: 40.3" Wheel circumference: 10.5'				Outlet area: 10.2 sq. ft. Maximum BHP = 24.5 $\left(\frac{\text{RPM}}{1000}\right)^3$			AF-30 = 2035 RPM AF-40 = 2470 RPM AF-50 = 2640 RPM										
CFM	OV	18"SP		22"SP		26"SP		28"SP		30"SP		34"SP		38"SP		42"SP		46"SP		48"SP		50"SP	
		RPM	BHP	RPM	BHP	RPM	BHP	RPM	BHP	RPM	BHP	RPM	BHP	RPM	BHP	RPM	BHP	RPM	BHP	RPM	BHP	RPM	BHP
24000	2348	1540	76.9	1691	96	1828	115	1895	125	1960	135	2085	167	2203	189								
26600	2603	1574	85.9	1708	105	1836	124	1902	135	1966	146	2085	167	2210	204	2320	227	2432	253	2478	264		
29200	2857	1615	95.5	1735	115	1858	136	1918	146	1976	157	2090	179	2210	204								
31800	3112	1665	107	1775	126	1886	148	1947	160	2000	170	2111	194	2221	218	2320	242	2429	268	2478	281	2530	295
34400	3366	1721	119	1827	140	1928	162	1980	173	2036	186	2133	208	2241	235	2339	260	2438	286	2492	301	2539	314
37000	3620	1785	132	1880	154	1977	177	2023	188	2071	200	2173	227	2262	251	2360	278	2452	304	2501	318	2551	334
39600	3875	1850	147	1939	170	2034	195	2078	207	2124	220	2212	244	2302	271	2388	297	2481	326	2526	340	2567	354
42200	4129	1920	164	2004	188	2089	212	2131	225	2176	238	2260	265	2341	291	2429	319	2510	347	2553	362	2598	378
44800	4384	1991	181	2071	206	2150	232	2192	245	2235	260	2312	286	2396	315	2469	342	2552	372	2593	388	2629	402
47400	4638	2068	202	2144	228	2218	254	2259	268	2293	281	2373	311	2449	340	2519	367	2594	397	2633	413		

MODEL 445		WITH EVASE				Wheel diameter: 44.5" Wheel circumference: 11.7'				Outlet area: 12.5 sq. ft. Maximum BHP = 40.3 $\left(\frac{\text{RPM}}{1000}\right)^3$			AF-30 = 1850 RPM AF-40 = 2230 RPM AF-50 = 2400 RPM										
CFM	OV	18"SP		22"SP		26"SP		28"SP		30"SP		34"SP		38"SP		42"SP		46"SP		48"SP		50"SP	
		RPM	BHP	RPM	BHP	RPM	BHP	RPM	BHP	RPM	BHP	RPM	BHP	RPM	BHP	RPM	BHP	RPM	BHP	RPM	BHP	RPM	BHP
30000	2398	1409	97.6	1537	120	1661	144	1722	157	1780	169	1886	193.0	1996	236	2099	265	2194	294	2249	311	2288	323
33200	2654	1436	108	1554	131	1671	156	1730	170	1788	183	1897	210	2006	255	2106	285	2199	315	2249	332	2293	347
36400	2910	1466	118	1584	144	1692	170	1752	185	1805	199	1909	227	2006	255								
39600	3165	1509	131	1616	158	1722	186	1773	200	1828	215	1924	244	2019	273	2116	305	2209	337	2254	353	2301	371
42800	3421	1556	145	1656	172	1752	201	1805	217	1851	231	1951	263	2039	293	2135	328	2221	360	2262	376	2306	393
46000	3677	1604	159	1697	187	1790	217	1840	234	1884	249	1978	283	2066	315	2150	348	2235	382	2280	401	2320	417
49200	3933	1661	175	1748	205	1834	236	1878	252	1924	270	2009	303	2092	336	2177	372	2257	406	2305	428	2343	445
52400	4189	1718	193	1801	224	1884	257	1923	273	1964	289	2050	326	2124	359	2205	395	2291	436	2325	452	2361	470
55600	4444	1780	213	1855	244	1933	278	1971	294	2010	312	2090	348	2166	385	2243	423	2315	459	2358	482	2391	499
58800	4700	1844	235	1915	267	1989	301	2026	319	2064	338	2137	374	2206	410	2280	450	2354	490	2390	510		

MODEL 495		WITH EVASE				Wheel diameter: 49.0" Wheel circumference: 12.8'				Outlet area: 15.3 sq. ft. Maximum BHP = 65.5 $\left(\frac{\text{RPM}}{1000}\right)^3$			AF-30 = 1675 RPM AF-40 = 2025 RPM AF-50 = 2170 RPM										
CFM	OV	18"SP		22"SP		26"SP		28"SP		30"SP		34"SP		38"SP		42"SP		46"SP		48"SP		50"SP	
		RPM	BHP	RPM	BHP	RPM	BHP	RPM	BHP	RPM	BHP	RPM	BHP	RPM	BHP	RPM	BHP	RPM	BHP	RPM	BHP	RPM	BHP
36000	2361	1267	116	1380	142	1500	172	1556	187	1610	202	1711	250	1810	285								
40000	2623	1295	130	1404	158	1507	187	1558	202	1611	218	1711	250	1810	285								
44000	2885	1336	146	1430	174	1526	205	1572	220	1621	236	1716	270	1811	305	1903	342	1990	378				
48000	3148	1383	164	1471	194	1558	225	1601	241	1646	258	1734	293	1822	329	1905	365	1990	403	2032	423	2075	444
52000	3410	1435	184	1516	216	1596	248	1637	265	1675	281	1758	317	1839	354	1922	393	2000	431	2038	451	2078	471
56000	3672	1493	207	1566	239	1640	272	1679	291	1716	308	1791	344	1867	383	1940	420	2018	462	2054	482	2091	503
60000	3934	1552	232	1621	266	1693	302	1728	320	1760	336	1831	375	1900	413	1969	452	2043	495	2076	515	2110	536
64000	4197	1615	260	1680	295	1744	331	1778	350	1813	370	1875	407	1941	447	2007	489	2072	531	2104	551	2137	573
68000	4459	1682	292	1741	327	1805	366	1834	385	1865	404	1925	444	1989	487	2049	527	2112	571	2142	593		
72000	4721	1748	325	1807	364	1863	401	1892	422	1923	443	1978	482	2037	525	2099	572	2155	615				

Performance shown is for AF Fans with evase discharges, with outlet ducts, and with or without inlet ducts. BHP does not include belt losses.

MODEL 545		WITH EVASE		Wheel diameter: 54.3" Wheel circumference: 14.2'				Outlet area: 18.7 sq. ft. Maximum BHP = 109 $\left(\frac{\text{RPM}}{1000}\right)^3$				AF-30 = 1500 RPM AF-40 = 1830 RPM AF-50 = 1970 RPM												
CFM	OV	18"SP		22"SP		26"SP		28"SP		30"SP		34"SP		38"SP		42"SP		46"SP		48"SP		50"SP		
		RPM	BHP	RPM	BHP	RPM	BHP	RPM	BHP	RPM	BHP	RPM	BHP	RPM	BHP	RPM	BHP	RPM	BHP	RPM	BHP	RPM	BHP	
45000	2413	1153	146	1255	179	1358	215	1403	232	1457	253	1545	290.0	1639	331.0	1720	371.0							
49600	2660	1178	162	1274	196	1368	233	1413	252	1462	273	1547	311	1636	354	1723	398	1795	438					
54200	2906	1209	179	1299	216	1387	254	1429	273	1469	292	1556	335	1643	380	1722	423	1801	469	1836	490			
58800	3153	1246	199	1326	235	1409	275	1453	297	1490	317	1572	360	1647	403	1723	448	1801	497	1840	522	1873	544	
63400	3399	1287	221	1365	261	1441	302	1479	322	1515	343	1592	388	1667	434	1738	480	1811	529	1846	553	1883	580	
68000	3646	1332	245	1402	285	1476	329	1512	351	1546	372	1616	417	1686	464	1754	511	1827	564	1860	589	1894	615	
72600	3893	1378	271	1447	314	1512	357	1547	381	1581	403	1647	450	1711	497	1779	548	1843	599	1875	624	1907	650	
77200	4139	1427	300	1492	345	1554	389	1588	415	1617	436	1681	486	1743	534	1804	585	1870	640	1900	666	1930	693	
81800	4386	1481	333	1540	378	1601	426	1631	450	1659	473	1718	523	1782	578	1842	631	1896	681	1924	707	1954	735	
86400	4633	1533	367	1592	416	1646	462	1676	489	1704	513	1762	566	1820	621	1874	673	1931	729	1958	757			

MODEL 605		WITH EVASE		Wheel diameter: 60.0" Wheel circumference: 15.7'				Outlet area: 22.7 sq. ft. Maximum BHP = 180 $\left(\frac{\text{RPM}}{1000}\right)^3$				AF-30 = 1375 RPM AF-40 = 1655 RPM AF-50 = 1780 RPM											
CFM	OV	18"SP		22"SP		26"SP		28"SP		30"SP		34"SP		38"SP		42"SP		46"SP		48"SP		50"SP	
		RPM	BHP	RPM	BHP	RPM	BHP	RPM	BHP	RPM	BHP	RPM	BHP	RPM	BHP	RPM	BHP	RPM	BHP	RPM	BHP	RPM	BHP
54000	2376	1039	175	1134	216	1226	259	1273	282	1313	303												
59600	2622	1059	193	1147	235	1235	281	1277	304	1318	327	1397	375	1475	424	1555	479						
65200	2868	1086	214	1169	259	1251	306	1291	330	1328	353	1405	403	1481	456	1554	510	1628	567	1661	594	1695	622
70800	3115	1120	239	1194	283	1271	332	1308	357	1347	384	1419	435	1489	488	1561	545	1629	601	1665	632	1696	660
76400	3361	1154	263	1226	312	1297	362	1332	388	1365	413	1433	465	1502	522	1569	580	1637	640	1670	671	1699	698
82000	3608	1195	293	1259	341	1328	395	1358	420	1390	446	1458	504	1520	559	1588	622	1646	679	1677	709	1709	742
87600	3854	1236	324	1300	377	1361	430	1390	456	1421	484	1483	541	1546	603	1606	663	1661	721	1695	757	1721	785
93200	4100	1280	359	1338	412	1398	469	1427	497	1457	527	1514	585	1571	645	1628	708	1685	772	1713	804	1742	838
98800	4347	1328	398	1384	454	1437	510	1466	540	1492	569	1547	630	1603	694	1658	760	1709	822	1736	855	1763	889
104400	4593	1376	440	1428	497	1481	558	1506	587	1532	617	1583	679	1637	747	1687	811	1740	881	1766	915		

MODEL 665		WITH EVASE		Wheel diameter: 66.0" Wheel circumference: 17.3'				Outlet area: 27.7 sq. ft. Maximum BHP = 291 $\left(\frac{\text{RPM}}{1000}\right)^3$				AF-30 = 1250 RPM AF-40 = 1505 RPM AF-50 = 1605 RPM											
CFM	OV	18"SP		22"SP		26"SP		28"SP		30"SP		34"SP		38"SP		42"SP		46"SP		48"SP		50"SP	
		RPM	BHP	RPM	BHP	RPM	BHP	RPM	BHP	RPM	BHP	RPM	BHP	RPM	BHP	RPM	BHP	RPM	BHP	RPM	BHP	RPM	BHP
67000	2421	949	217	1035	268	1114	318	1156	347	1196	375	1271	431.0	1343	489.0								
74000	2674	970	241	1050	294	1126	348	1164	376	1200	404	1276	466	1346	528								
81000	2927	997	268	1070	322	1140	378	1176	407	1213	439	1278	497	1351	566	1411	626	1477	696	1512	735	1543	769
88000	3180	1029	299	1094	353	1161	412	1194	443	1229	476	1294	539	1357	604	1422	674	1483	743	1515	781	1543	815
95000	3433	1065	333	1125	390	1187	450	1218	482	1252	517	1309	579	1373	650	1433	721	1489	790	1519	827	1550	868
102000	3686	1100	369	1160	430	1217	492	1248	527	1277	560	1335	629	1391	698	1449	771	1506	847	1534	886	1558	919
109000	3939	1142	411	1198	476	1251	540	1278	573	1306	609	1360	677	1414	750	1468	825	1522	903	1549	942	1576	983
116000	4192	1184	456	1237	524	1287	590	1314	626	1338	659	1390	733	1442	809	1491	882	1543	963	1568	1003	1589	1038
123000	4445	1229	507	1278	575	1327	647	1350	681	1374	718	1422	791	1473	872	1520	950	1566	1028	1591	1069		
130000	4698	1273	559	1322	634	1366	703	1389	740	1412	780	1459	859	1506	940	1548	1015	1593	1097				

Performance shown is for AF Fans with evase discharges, with outlet ducts, and with or without inlet ducts. BHP does not include belt losses.

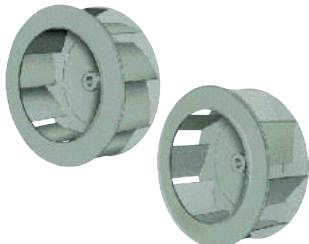
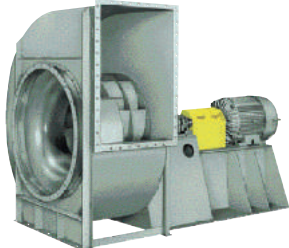
<p>MEDIUM-PRESSURE FANS FOR CLEAN-AIR APPLICATIONS</p> <p>Refer to separate bulletin on each product line.</p>	 <p>CLASS I, II, AND III FANS High-efficiency backward inclined fans in 16 sizes. Capacities to 200,000 CFM [5700 CMM], static pressures to 14" [3.50 kPa].</p>	 <p>WHEEL CHOICES Two wheel designs to meet a wide variety of performance requirements and airstream conditions.</p>	 <p>CLASS IV FANS For applications requiring capacities to 170,000 CFM [4800 CMM] and static pressures to 20" [5.0 kPa].</p>
---	---	---	--

MODEL 245		WITHOUT EVASE				Wheel diameter: 24.5" Wheel circumference: 6.41'			Outlet area: 2.38 sq. ft. Maximum BHP = 1.84 $\left(\frac{\text{RPM}}{1000}\right)^3$			AF-30 = 3300 RPM AF-40 = 4000 RPM AF-50 = 4250 RPM											
CFM	OV	18"SP		22"SP		26"SP		28"SP		30"SP		34"SP		38"SP		42"SP		46"SP		48"SP		50"SP	
		RPM	BHP	RPM	BHP	RPM	BHP	RPM	BHP	RPM	BHP	RPM	BHP	RPM	BHP	RPM	BHP	RPM	BHP	RPM	BHP	RPM	BHP
8000	3361	2629	29.6	2835	36.2	3054	44.2	3153	48.2	3259	52.6	3453	61.1	3656	70.7	3834	79.8	4010	94.3	4107	100	4192	106
9000	3782	2721	33.5	2916	40.5	3103	47.9	3201	52.1	3294	56.3	3487	65.5	3663	74.6	3843	84.6	4036	100	4121	106	4195	111
10000	4202	2835	38.5	3017	45.7	3190	53.2	3279	57.4	3364	61.5	3536	70.4	3704	79.7	3863	89.2	4036	100	4121	106	4195	111
11000	4622	2942	43.7	3121	51.3	3289	59.3	3372	63.5	3450	67.7	3608	76.4	3771	86.1	3925	96.0	4068	106	4144	111	4222	117
12000	5042	3052	49.1	3233	57.8	3399	66.4	3477	70.6	3558	75.3	3706	84.2	3846	93.2	3987	103	4139	114	4208	119		
13000	5462	3169	55.3	3341	64.4	3505	73.7	3593	78.9	3669	83.6	3816	93.1	3957	103	4088	112	4208	122				
14000	5882	3288	62.0	3458	71.8	3620	81.8	3696	86.8	3776	92.1	3921	102	4061	112	4184	122						
15000	6303	3414	69.6	3583	80.1	3731	90.0	3810	95.6	3878	101	4021	111	4160	122								
16000	6723	3537	77.6	3699	88.4	3851	99.3	3926	105	4003	111	4140	122										
17000	7143	3667	86.6	3827	98.2	3979	110	4050	116	4117	121												

MODEL 275		WITHOUT EVASE				Wheel diameter: 27.0" Wheel circumference: 7.07'			Outlet area: 2.77 sq. ft. Maximum BHP = 3.14 $\left(\frac{\text{RPM}}{1000}\right)^3$			AF-30 = 3000 RPM AF-40 = 3680 RPM AF-50 = 3900 RPM											
CFM	OV	18"SP		22"SP		26"SP		28"SP		30"SP		34"SP		38"SP		42"SP		46"SP		48"SP		50"SP	
		RPM	BHP	RPM	BHP	RPM	BHP	RPM	BHP	RPM	BHP	RPM	BHP	RPM	BHP	RPM	BHP	RPM	BHP	RPM	BHP	RPM	BHP
10000	3610	2346	35.7	2560	44.4	2767	53.7	2858	58.1	2965	63.5	3143	73.1	3330	83.9	3493	94.1	3662	115	3734	120	3810	126
11500	4152	2418	40.8	2620	50.4	2808	60.0	2895	64.7	2987	69.9	3168	80.8	3325	90.9	3498	103	3662	115	3745	130	3823	137
13000	4693	2518	47.2	2696	56.9	2863	66.7	2955	72.3	3036	77.5	3194	88.0	3359	99.8	3519	112	3671	124	3745	130	3823	137
14500	5235	2630	54.3	2795	64.7	2949	74.9	3032	80.7	3105	86.0	3263	97.8	3410	109	3561	122	3704	135	3780	142	3848	148
16000	5776	2753	62.4	2903	73.1	3052	84.4	3123	89.9	3197	95.9	3341	108	3482	120	3617	133	3755	146	3822	153	3892	160
17500	6318	2886	71.6	3030	83.2	3165	94.7	3237	101	3300	107	3433	119	3563	132	3702	146	3818	159	3888	166		
19000	6859	3024	81.8	3162	94.3	3291	107	3354	113	3419	119	3544	133	3664	146	3793	160						
20500	7401	3173	93.6	3301	107	3425	120	3479	126	3540	133	3664	147	3777	161	3890	175						
22000	7942	3322	106	3442	120	3559	134	3616	141	3669	147	3781	162	3899	177								
23500	8484	3477	121	3588	135	3701	149	3760	157	3811	164												

MODEL 305		WITHOUT EVASE				Wheel diameter: 30.0" Wheel circumference: 7.85'			Outlet area: 3.36 sq. ft. Maximum BHP = 5.32 $\left(\frac{\text{RPM}}{1000}\right)^3$			AF-30 = 2700 RPM AF-40 = 3310 RPM AF-50 = 3550 RPM											
CFM	OV	18"SP		22"SP		26"SP		28"SP		30"SP		34"SP		38"SP		42"SP		46"SP		48"SP		50"SP	
		RPM	BHP	RPM	BHP	RPM	BHP	RPM	BHP	RPM	BHP	RPM	BHP	RPM	BHP	RPM	BHP	RPM	BHP	RPM	BHP	RPM	BHP
12000	3571	2104	43.1	2301	53.8	2481	64.7	2567	70.2	2660	76.5	2830	88.8	2996	102	3140	125	3295	140	3364	147	3436	155
14000	4167	2173	50.0	2351	61.3	2520	73.1	2602	79.1	2680	85.1	2841	98.1	3000	112	3140	125	3295	140	3372	160	3445	169
16000	4762	2267	58.3	2422	69.8	2579	82.4	2658	89.0	2734	95.7	2883	109	3029	124	3170	138	3302	153	3372	160	3445	169
18000	5357	2371	67.4	2515	79.8	2659	93.0	2730	99.9	2805	107	2938	121	3067	135	3208	152	3333	167	3404	175	3467	184
20000	5952	2494	78.6	2631	92.2	2760	106	2827	113	2890	120	3018	135	3143	151	3270	167	3390	183	3444	191	3500	198
22000	6548	2626	91.3	2753	106	2870	120	2932	127	2991	135	3110	151	3232	167	3349	184	3458	201	3507	208		
24000	7143	2763	105	2880	120	2992	136	3051	144	3107	152	3219	169	3327	185	3435	202	3542	220				
26000	7738	2904	121	3018	138	3126	154	3177	162	3230	171	3337	188	3438	206	3539	224						
28000	8333	3054	139	3161	157	3260	174	3310	182	3361	191	3462	210										
30000	8929	3206	160	3305	178	3401	196	3449	205	3498	215												

MODEL 335		WITHOUT EVASE				Wheel diameter: 33.0" Wheel circumference: 8.64'			Outlet area: 4.11 sq. ft. Maximum BHP = 8.57 $\left(\frac{\text{RPM}}{1000}\right)^3$			AF-30 = 2500 RPM AF-40 = 3020 RPM AF-50 = 3205 RPM											
CFM	OV	18"SP		22"SP		26"SP		28"SP		30"SP		34"SP		38"SP		42"SP		46"SP		48"SP		50"SP	
		RPM	BHP	RPM	BHP	RPM	BHP	RPM	BHP	RPM	BHP	RPM	BHP	RPM	BHP	RPM	BHP	RPM	BHP	RPM	BHP	RPM	BHP
15000	3650	1919	53.4	2096	66.6	2257	79.9	2343	87.5	2417	94.3	2579	110	2716	125	2861	152	2992	170	3056	179	3123	188
17000	4136	1977	60.7	2136	74.2	2286	88.1	2361	95.5	2442	104	2583	119	2720	135	2861	152	2992	170	3058	191	3128	202
19000	4623	2042	68.5	2194	83.2	2331	97.4	2406	106	2471	113	2612	130	2742	147	2876	165	3002	183	3058	191	3128	202
21000	5109	2123	77.8	2261	93.0	2394	109	2457	116	2523	125	2652	142	2778	159	2898	177	3020	196	3079	206	3141	216
23000	5596	2209	88.0	2336	104	2462	120	2527	129	2588	138	2708	155	2824	173	2934	191	3052	211	3106	220	3162	230
25000	6083	2306	99.9	2424	116	2544	134	2599	142	2658	151	2770	170	2878	188	2994	209	3104	229	3154	238	3205	248
27000	6569	2407	113	2518	130	2628	148	2681	157	2737	167	2843	186	2945	205	3054	226	3156	247	3202	256		
29000	7056	2510	127	2613	145	2720	164	2772	174	2825	184	2927	204	3024	224	3120	244						
31000	7543	2618	143	2720	163	2819	182	2869	193	2916	202	3008	222	3106	244	3199	265						
33000	8029	2724	160	2824	181	2916	201	2965	212	3015	223	3104	244	3193	266								

Performance shown is for AF Fans without evase discharges, with outlet ducts, and with or without inlet ducts. BHP does not include belt losses.

MODEL 365		WITHOUT EVASE				Wheel diameter: 36.5" Wheel circumference: 9.56'				Outlet area: 5.07 sq. ft. Maximum BHP = 14.2 $\left(\frac{\text{RPM}}{1000}\right)^3$				AF-30 = 2250 RPM AF-40 = 2720 RPM AF-50 = 2900 RPM									
CFM	OV	18"SP		22"SP		26"SP		28"SP		30"SP		34"SP		38"SP		42"SP		46"SP		48"SP		50"SP	
		RPM	BHP	RPM	BHP	RPM	BHP	RPM	BHP	RPM	BHP	RPM	BHP	RPM	BHP	RPM	BHP	RPM	BHP	RPM	BHP	RPM	BHP
18000	3550	1730	64.2	1887	79.8	2044	97.0	2117	106	2185	114	2326	133										
20500	4043	1779	73.0	1926	89.6	2065	107	2135	116	2202	125	2333	144	2461	164	2592	186	2704	205	2763	216		
23000	4536	1841	82.9	1976	100	2102	118	2171	128	2232	137	2362	158	2475	178	2600	200	2717	223	2769	233	2822	244
25500	5030	1911	94.0	2039	113	2162	132	2220	142	2282	152	2394	172	2503	193	2614	215	2727	238	2782	250	2830	261
28000	5523	1996	107	2109	126	2220	146	2279	157	2331	166	2441	188	2548	210	2657	234	2760	258	2810	269	2862	282
30500	6016	2080	121	2190	142	2296	163	2348	173	2402	185	2506	208	2606	231	2701	253	2802	279	2848	291	2896	303
33000	6509	2174	138	2276	159	2374	181	2424	192	2470	203	2569	227	2663	250	2758	275	2846	299	2896	313		
35500	7002	2268	155	2368	179	2459	201	2507	213	2552	224	2641	248	2731	273	2821	299						
38000	7495	2367	175	2462	199	2551	223	2593	235	2641	249	2722	272	2809	299	2895	326						
40500	7988	2472	198	2557	222	2644	248	2685	260	2728	273	2812	300	2890	326								

MODEL 405		WITHOUT EVASE				Wheel diameter: 40.3" Wheel circumference: 10.5'				Outlet area: 6.16 sq. ft. Maximum BHP = 24.6 $\left(\frac{\text{RPM}}{1000}\right)^3$				AF-30 = 2035 RPM AF-40 = 2470 RPM AF-50 = 2640 RPM									
CFM	OV	18"SP		22"SP		26"SP		28"SP		30"SP		34"SP		38"SP		42"SP		46"SP		48"SP		50"SP	
		RPM	BHP	RPM	BHP	RPM	BHP	RPM	BHP	RPM	BHP	RPM	BHP	RPM	BHP	RPM	BHP	RPM	BHP	RPM	BHP	RPM	BHP
24000	3896	1584	84.8	1728	105	1873	127	1937	138	2005	150	2139	174										
26600	4318	1613	93.3	1750	115	1887	138	1950	149	2011	161	2138	186	2255	211	2375	238	2488	266				
29200	4740	1650	103	1777	125	1902	148	1966	161	2028	173	2142	198	2262	225	2379	254	2488	282	2537	296	2588	310
31800	5162	1701	114	1818	137	1936	161	1995	174	2052	187	2163	213	2273	240	2379	268	2486	297	2539	312	2594	329
34400	5584	1755	126	1866	150	1973	175	2029	188	2082	201	2186	227	2294	256	2398	286	2504	317	2553	332	2603	348
37000	6006	1813	140	1917	164	2020	190	2073	204	2123	218	2221	245	2322	274	2420	304	2518	335	2562	350	2609	365
39600	6429	1876	154	1974	180	2069	206	2115	220	2164	234	2262	263	2357	294	2449	324	2541	355	2589	372	2632	388
42200	6851	1945	171	2038	198	2126	225	2171	239	2217	254	2307	283	2398	314	2485	345	2578	380	2617	395		
44800	7273	2016	189	2099	216	2185	244	2229	259	2270	274	2356	304	2438	335	2526	369	2609	401				
47400	7695	2088	209	2167	236	2252	267	2290	281	2334	298	2414	329	2493	361	2573	394						

MODEL 445		WITHOUT EVASE				Wheel diameter: 44.5" Wheel circumference: 11.7'				Outlet area: 7.55 sq. ft. Maximum BHP = 40.6 $\left(\frac{\text{RPM}}{1000}\right)^3$				AF-30 = 1850 RPM AF-40 = 2230 RPM AF-50 = 2400 RPM									
CFM	OV	18"SP		22"SP		26"SP		28"SP		30"SP		34"SP		38"SP		42"SP		46"SP		48"SP		50"SP	
		RPM	BHP	RPM	BHP	RPM	BHP	RPM	BHP	RPM	BHP	RPM	BHP	RPM	BHP	RPM	BHP	RPM	BHP	RPM	BHP	RPM	BHP
30000	3974	1438	106	1564	130	1695	158	1753	171	1814	186	1927	214										
33200	4397	1465	116	1590	143	1704	170	1767	186	1823	200	1930	229	2043	262	2143	294	2245	327	2294	344		
36400	4821	1503	129	1615	156	1730	185	1783	200	1839	215	1944	246	2046	279	2151	314	2251	350	2295	366	2341	384
39600	5245	1546	142	1653	171	1756	200	1811	216	1858	231	1959	263	2059	297	2155	332	2253	369	2301	388	2343	405
42800	5669	1598	158	1697	187	1791	217	1842	234	1892	250	1987	284	2080	318	2176	355	2266	392	2310	411	2348	427
46000	6093	1654	175	1743	204	1838	237	1883	254	1925	269	2015	303	2108	341	2197	378	2281	415	2329	437	2371	457
49200	6517	1712	193	1799	225	1883	257	1926	274	1971	293	2057	329	2141	365	2219	401	2304	441	2342	459	2389	482
52400	6940	1774	214	1856	247	1939	282	1977	298	2016	316	2099	353	2179	391	2254	428	2334	469	2370	487		
55600	7364	1838	236	1916	271	1993	306	2030	324	2068	342	2144	379	2221	419	2298	460	2369	499				
58800	7788	1907	262	1977	296	2053	334	2089	353	2123	370	2197	410	2267	449	2342	491						

MODEL 495		WITHOUT EVASE				Wheel diameter: 49.0" Wheel circumference: 12.8'				Outlet area: 9.21 sq. ft. Maximum BHP = 65.8 $\left(\frac{\text{RPM}}{1000}\right)^3$				AF-30 = 1675 RPM AF-40 = 2025 RPM AF-50 = 2170 RPM									
CFM	OV	18"SP		22"SP		26"SP		28"SP		30"SP		34"SP		38"SP		42"SP		46"SP		48"SP		50"SP	
		RPM	BHP	RPM	BHP	RPM	BHP	RPM	BHP	RPM	BHP	RPM	BHP	RPM	BHP	RPM	BHP	RPM	BHP	RPM	BHP	RPM	BHP
36000	3909	1303	127	1425	158	1537	190	1590	206	1648	224	1753	259										
40000	4343	1328	140	1443	173	1549	206	1603	223	1654	241	1755	277	1853	315	1946	354						
44000	4777	1362	155	1470	189	1568	223	1617	241	1669	260	1766	298	1861	338	1952	379	2036	419	2086	443	2128	465
48000	5212	1408	173	1503	208	1595	243	1641	261	1689	281	1784	321	1871	361	1961	404	2045	447	2089	470	2128	491
52000	5646	1454	192	1543	228	1631	265	1674	284	1719	304	1808	346	1889	386	1978	432	2055	475	2096	498	2139	522
56000	6080	1505	213	1588	250	1672	290	1714	310	1753	329	1832	370	1913	413	1996	460	2074	506	2112	529	2151	553
60000	6515	1560	237	1638	275	1716	316	1752	335	1794	357	1870	400	1947	445	2020	490	2093	536	2129	559	2166	584
64000	6949	1619	263	1693	303	1766	345	1801	365	1838	387	1911	432	1980	476	2050	522	2125	573	2158	597		
68000	7383	1679	292	1749	333	1818	376	1852	398	1888	421	1955	466	2022	513	2094	564	2156	609				
72000	7818	1741	322	1807	366	1875	412	1905	433	1936	455	2002	502	2067	551	2132	601						



Performance shown is for AF Fans without evase discharges, with outlet ducts, and with or without inlet ducts. BHP does not include belt losses.

MODEL 545		WITHOUT EVASE		Wheel diameter: 54.3" Wheel circumference: 14.2'				Outlet area: 11.3 sq. ft. Maximum BHP = 109 $\left(\frac{RPM}{1000}\right)^3$				AF-30 = 1500 RPM AF-40 = 1830 RPM AF-50 = 1970 RPM											
CFM	OV	18"SP		22"SP		26"SP		28"SP		30"SP		34"SP		38"SP		42"SP		46"SP		48"SP		50"SP	
		RPM	BHP	RPM	BHP	RPM	BHP	RPM	BHP	RPM	BHP	RPM	BHP	RPM	BHP	RPM	BHP	RPM	BHP	RPM	BHP	RPM	BHP
45000	3996	1182	159	1287	196	1391	236	1439	256	1490	278	1584	322										
49600	4405	1204	174	1305	214	1401	255	1449	276	1496	298	1586	343			1675	390	1759	438	1843	490	1885	516
54200	4813	1233	191	1327	233	1421	276	1465	298	1508	320	1596	367			1677	414	1766	468	1843	518	1880	543
58800	5222	1268	211	1356	253	1440	297	1481	319	1526	344	1612	394			1692	444	1768	493	1845	546	1886	575
63400	5631	1308	233	1389	277	1470	322	1510	346	1547	369	1628	420			1708	473	1784	527	1855	579	1893	608
68000	6039	1352	257	1428	303	1506	351	1540	374	1576	398	1654	451			1729	505	1801	560	1867	612	1902	641
72600	6448	1400	285	1472	332	1541	379	1578	406	1612	431	1683	484			1750	536	1818	591	1891	653	1924	682
77200	6856	1448	314	1517	363	1581	411	1617	439	1647	463	1715	518			1780	573	1844	630	1914	693	1946	723
81800	7265	1499	346	1563	396	1627	448	1659	475	1688	501	1750	555			1817	617	1880	676	1937	732	1967	762
86400	7673	1550	379	1611	432	1671	485	1702	514	1735	544	1792	599			1853	659	1914	721	1970	780		

MODEL 605		WITHOUT EVASE		Wheel diameter: 60.0" Wheel circumference: 15.7'				Outlet area: 13.7 sq. ft. Maximum BHP = 181 $\left(\frac{RPM}{1000}\right)^3$				AF-30 = 1375 RPM AF-40 = 1655 RPM AF-50 = 1780 RPM											
CFM	OV	18"SP		22"SP		26"SP		28"SP		30"SP		34"SP		38"SP		42"SP		46"SP		48"SP		50"SP	
		RPM	BHP	RPM	BHP	RPM	BHP	RPM	BHP	RPM	BHP	RPM	BHP	RPM	BHP	RPM	BHP	RPM	BHP	RPM	BHP	RPM	BHP
54000	3950	1062	190	1164	237	1257	285	1302	310	1344	335	1432	388										
59600	4360	1083	209	1173	255	1266	308	1306	332	1349	359	1434	415			1517	474	1589	529	1668	593		
65200	4770	1111	231	1196	280	1279	332	1321	359	1361	386	1443	445			1518	502	1589	560	1668	628	1702	659
70800	5179	1141	254	1218	303	1300	359	1335	384	1376	415	1452	474			1527	535	1598	597	1669	663	1701	693
76400	5589	1177	280	1252	334	1323	388	1360	417	1395	445	1471	509			1536	567	1607	633	1673	698	1709	734
82000	5999	1213	308	1284	363	1353	421	1388	451	1422	481	1490	543			1556	606	1622	673	1690	744	1717	774
87600	6408	1256	341	1320	397	1387	458	1418	487	1451	518	1516	583			1579	649	1642	717	1706	789	1737	826
93200	6818	1300	377	1361	434	1424	497	1454	528	1486	561	1545	626			1606	694	1662	760	1727	839	1757	876
98800	7228	1346	415	1403	474	1462	539	1491	572	1519	603	1577	671			1635	742	1690	811	1748	886	1776	924
104400	7637	1392	456	1446	517	1502	583	1531	619	1558	652	1611	720			1668	794	1721	866	1777	945		

MODEL 665		WITHOUT EVASE		Wheel diameter: 66.0" Wheel circumference: 17.3'				Outlet area: 16.7 sq. ft. Maximum BHP = 292 $\left(\frac{RPM}{1000}\right)^3$				AF-30 = 1250 RPM AF-40 = 1505 RPM AF-50 = 1605 RPM											
CFM	OV	18"SP		22"SP		26"SP		28"SP		30"SP		34"SP		38"SP		42"SP		46"SP		48"SP		50"SP	
		RPM	BHP	RPM	BHP	RPM	BHP	RPM	BHP	RPM	BHP	RPM	BHP	RPM	BHP	RPM	BHP	RPM	BHP	RPM	BHP	RPM	BHP
67000	4002	970	235	1058	291	1141	350	1186	383	1224	413	1303	478										
74000	4421	992	260	1073	318	1153	380	1194	413	1228	443	1304	510			1378	582	1448	655				
81000	4839	1017	287	1094	348	1169	412	1202	442	1242	479	1311	546			1379	616	1448	692	1512	767	1549	813
88000	5257	1048	318	1119	381	1190	448	1222	479	1255	513	1324	586			1391	661	1454	736	1519	817	1547	854
95000	5675	1082	352	1149	417	1214	485	1247	521	1276	553	1344	632			1403	704	1467	785	1526	865	1558	910
102000	6093	1120	390	1182	458	1242	527	1271	561	1302	599	1364	676			1423	755	1484	839	1540	920	1569	964
109000	6511	1158	430	1217	500	1276	575	1304	612	1334	651	1390	728			1443	805	1500	890	1558	979	1581	1017
116000	6930	1200	475	1255	549	1310	625	1338	664	1364	702	1418	783			1470	863	1525	952	1576	1037	1602	1082
123000	7348	1245	527	1295	600	1347	678	1374	720	1399	760	1449	841			1499	925	1548	1011	1601	1107		
130000	7766	1289	579	1339	659	1387	739	1411	780	1436	823	1485	909			1534	999	1579	1082				

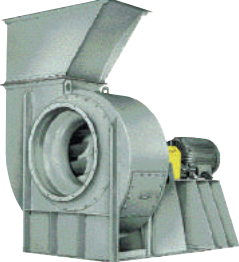
Performance shown is for AF Fans without evase discharges, with outlet ducts, and with or without inlet ducts. BHP does not include belt losses.

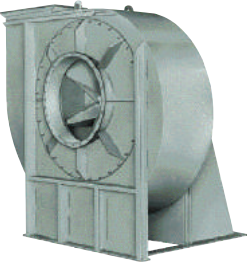
<p>HIGH-PRESSURE FANS WITH MATERIAL HANDLING-CAPABILITIES</p> <p>Refer to separate bulletin on each product line.</p>	 <p>RTS FANS</p> <p>High-efficiency, radial-tip wheel suitable for particulate-laden airstreams. Capacities to 250,000 CFM [7080 CMM], static pressures to 36" [8.9 kPa].</p>	 <p>SERIES 30 GI FANS</p> <p>Feature performance up to 95,000 CFM [2700 CMM] and 32" [7.9 kPa] static pressure...also available with extra-rugged BP and RD wheels for severe-duty applications.</p>	 <p>SERIES 45 GI FANS</p> <p>Are specifically designed to handle higher-pressure applications...to 100,000 CFM [2800 CMM] and 46" [11.0 kPa] static pressure.</p>
--	---	---	---

MATERIAL SPECIFICATIONS [INCHES, POUNDS, WR² IN LB.-FT.²]

AF-30 FANS															
Model	Shaft diameter				Bearings*				Wheel		Bare fan weight				
	Arr. 1	Arr. 3	Arr. 7	Arr. 8	Arr. 1	Arr. 3	Arr. 7	Arr. 8	Weight	WR ²	Arr. 1	Arr. 3	Arr. 4	Arr. 7	Arr. 8
245	2 ³ / ₁₆	1 ¹¹ / ₁₆	—	1 ¹⁵ / ₁₆	6800	22400	—	300	109	52	890	740	820	—	1400
275	2 ⁷ / ₁₆	1 ¹⁵ / ₁₆	—	2 ¹¹ / ₁₆	6800	22400	—	300	111	67	1160	860	1130	—	1690
305	2 ¹¹ / ₁₆	1 ¹⁵ / ₁₆	—	2 ¹⁵ / ₁₆	6800	22400	—	300	149	105	1380	1050	1660	—	2460
335	2 ¹⁵ / ₁₆	2 ³ / ₁₆	—	2 ¹⁵ / ₁₆	6800	22400	—	300	172	153	1780	1280	1900	—	2820
365	2 ¹⁵ / ₁₆	2 ⁷ / ₁₆	—	2 ¹⁵ / ₁₆	6800	22400	—	300	268	264	2200	1600	1870	—	2930
405	3 ⁷ / ₁₆	2 ¹¹ / ₁₆	2 ¹¹ / ₁₆	2 ¹⁵ / ₁₆	6800	22400	300	300	330	421	2620	1980	2360	3000	3530
445	3 ⁷ / ₁₆	2 ¹¹ / ₁₆	2 ¹¹ / ₁₆	3 ⁷ / ₁₆	6800	22400	300	300	403	665	3120	2330	2830	3560	4310
495	3 ¹⁵ / ₁₆	2 ¹⁵ / ₁₆	2 ¹⁵ / ₁₆	3 ¹⁵ / ₁₆	6800	22400	300	300	463	957	3680	2740	3260	4650	5590
545	4 ⁷ / ₁₆	3 ⁷ / ₁₆	3 ⁷ / ₁₆	4 ⁷ / ₁₆	6800	6800	300	6800	770	1778	4980	3730	—	5630	6830
605	4 ⁷ / ₁₆	3 ⁷ / ₁₆	3 ⁷ / ₁₆	4 ⁷ / ₁₆	6800	6800	300	6800	949	2830	5910	4620	—	6580	7820
665	4 ¹⁵ / ₁₆	3 ¹⁵ / ₁₆	3 ¹⁵ / ₁₆	4 ¹⁵ / ₁₆	6800	6800	300	6800	1118	4283	6990	5260	—	7280	8920

AF-40 FANS															
Model	Shaft diameter				Bearings*				Wheel		Bare fan weight				
	Arr. 1	Arr. 3	Arr. 7	Arr. 8		Arr. 1/3	Arr. 7	Arr. 8	Weight	WR ²	Arr. 1	Arr. 3	Arr. 4	Arr. 7	Arr. 8
@ Brgs.				@ Wheel											
245	2 ³ / ₁₆	2 ³ / ₁₆	—	1 ¹⁵ / ₁₆	1 ¹⁵ / ₁₆	6800	—	300	120	61	900	790	840	—	1410
275	2 ¹¹ / ₁₆	2 ³ / ₁₆	—	2 ¹¹ / ₁₆	2 ¹¹ / ₁₆	6800	—	300	124	80	1200	910	1150	—	1700
305	2 ¹⁵ / ₁₆	2 ¹¹ / ₁₆	—	2 ¹⁵ / ₁₆	2 ¹⁵ / ₁₆	6800	—	300A	167	126	1410	1150	1680	—	2520
335	2 ¹⁵ / ₁₆	2 ¹⁵ / ₁₆	—	3 ⁷ / ₁₆	2 ¹⁵ / ₁₆	6800	—	300A	190	179	1800	1390	1920	—	2970
365	3 ⁷ / ₁₆	2 ¹⁵ / ₁₆	—	3 ⁷ / ₁₆	3 ⁷ / ₁₆	6800	—	300	293	308	2310	1700	1890	—	3030
405	3 ⁷ / ₁₆	3 ⁷ / ₁₆	2 ¹⁵ / ₁₆	3 ⁷ / ₁₆	3 ⁷ / ₁₆	6800	300	300	359	483	2650	2140	2390	3060	3640
445	3 ¹⁵ / ₁₆	3 ⁷ / ₁₆	2 ¹⁵ / ₁₆	3 ⁷ / ₁₆	3 ⁷ / ₁₆	6800	300	300	438	757	3230	2500	2870	3620	4340
495	3 ¹⁵ / ₁₆	3 ¹⁵ / ₁₆	2 ¹⁵ / ₁₆	3 ¹⁵ / ₁₆	3 ¹⁵ / ₁₆	6800	300	300	509	1095	3730	2990	3300	4700	5630
545	4 ⁷ / ₁₆	3 ¹⁵ / ₁₆	3 ⁷ / ₁₆	4 ⁷ / ₁₆	4 ⁷ / ₁₆	6800	300	6800	822	1985	5030	3860	—	5680	6880
605	4 ¹⁵ / ₁₆	4 ⁷ / ₁₆	3 ¹⁵ / ₁₆	4 ⁷ / ₁₆	4 ⁷ / ₁₆	6800	300	6800	1034	3253	6100	4970	—	6760	7900
665	5 ⁷ / ₁₆	4 ⁷ / ₁₆	3 ¹⁵ / ₁₆	4 ¹⁵ / ₁₆	4 ¹⁵ / ₁₆	6800	300	6800	1232	4952	7290	5570	—	7390	9040
735	—	—	3 ¹⁵ / ₁₆	4 ¹⁵ / ₁₆	4 ¹⁵ / ₁₆	—	22400	6800	1505	7311	—	—	—	O.A.	O.A.
805	—	—	4 ⁷ / ₁₆	5 ⁷ / ₁₆	5 ⁷ / ₁₆	—	22500	6800	2050	11698	—	—	—	O.A.	O.A.

O.A. – On application

AF-50 FANS															
Model	Shaft diameter				Bearings*				Wheel		Bare fan weight				
	Arr. 1		Arr. 3	Arr. 8		Arr. 1	Arr. 3	Arr. 8	Weight	WR ²	Arr. 1	Arr. 3	Arr. 4	Arr. 8	
	@ Brgs.	@ Wheel		@ Brgs.	@ Wheel										
245	2 ⁷ / ₁₆	2 ⁷ / ₁₆	2 ³ / ₁₆	1 ¹⁵ / ₁₆	1 ¹⁵ / ₁₆	300A	300A	300	120	61	950	820	840	1410	
275	2 ¹⁵ / ₁₆	2 ¹¹ / ₁₆	2 ⁷ / ₁₆	2 ¹¹ / ₁₆	2 ¹¹ / ₁₆	300A	300A	300	124	80	1280	960	1150	1700	
305	3 ⁷ / ₁₆	2 ¹⁵ / ₁₆	2 ¹¹ / ₁₆	2 ¹⁵ / ₁₆	2 ¹⁵ / ₁₆	300A	300A	300A	167	126	1550	1180	1680	2520	
335	3 ⁷ / ₁₆	2 ¹⁵ / ₁₆	2 ¹⁵ / ₁₆	3 ⁷ / ₁₆	2 ¹⁵ / ₁₆	300A	300A	300A	190	179	1940	1450	1920	2970	
365	3 ⁷ / ₁₆	3 ⁷ / ₁₆	3 ⁷ / ₁₆	3 ⁷ / ₁₆	3 ⁷ / ₁₆	300A	300A	300A	293	308	2370	1850	1890	3090	
405	3 ¹⁵ / ₁₆	3 ¹⁵ / ₁₆	3 ⁷ / ₁₆	3 ⁷ / ₁₆	3 ⁷ / ₁₆	6800	300A	300A	359	483	2720	2200	2390	3690	
445	—	—	—	3 ¹⁵ / ₁₆	3 ¹⁵ / ₁₆	—	—	6800	438	757	—	—	2870	4420	
495	—	—	—	3 ¹⁵ / ₁₆	3 ¹⁵ / ₁₆	—	—	6800	509	1095	—	—	3300	5610	
545	—	—	—	4 ¹⁵ / ₁₆	4 ¹⁵ / ₁₆	—	—	6800	822	1985	—	—	—	6970	
605	—	—	—	4 ¹⁵ / ₁₆	4 ¹⁵ / ₁₆	—	—	6800	1034	3253	—	—	—	8000	
665	—	—	—	5 ⁷ / ₁₆	5 ⁷ / ₁₆	—	—	6800	1232	4952	—	—	—	9220	

* nyb reserves the right to substitute bearings of equal ratings.

FLANGED OUTLET AND EVASE

1. Mounted flush with edge of housing outlet.
2. Furnished as standard with holes 4" centers from centerline.

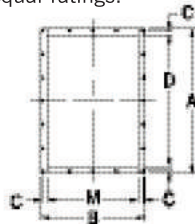

FLANGED INLET

Furnished as standard with holes starting on vertical centerline.

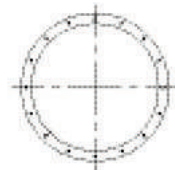

DIMENSIONS [INCHES]											
Model	A		B†	C	D		M†	Standard holes			
	Fan	Evase			Fan	Evase		Sides		†Top/ bottom	Size
					Fan	Evase					
245	25	39 ¹ / ₂	17 ¹ / ₂	3/4	22 ¹ / ₂	37	15	7	9	3	7/16
275	27 ³ / ₈	43 ¹ / ₂	19 ³ / ₈	3/4	24 ⁷ / ₈	41	16 ⁷ / ₈	7	11	3	7/16
305	30 ³ / ₈	48 ¹ / ₂	21 ¹ / ₂	7/8	27 ³ / ₈	45 ¹ / ₂	18 ¹ / ₂	7	11	5	7/16
335	33 ¹ / ₄	53	23 ³ / ₈	7/8	30 ¹ / ₄	50	20 ³ / ₈	9	13	5	7/16
365	36 ¹ / ₂	58 ¹ / ₄	25 ⁵ / ₈	7/8	33 ¹ / ₂	55 ¹ / ₄	22 ⁵ / ₈	9	15	5	7/16
405	39 ⁷ / ₈	63 ⁷ / ₈	27 ⁷ / ₈	7/8	36 ⁷ / ₈	60 ⁷ / ₈	24 ⁷ / ₈	9	15	5	7/16
445	44 ³ / ₄	71 ¹ / ₄	31 ¹ / ₂	1 ¹ / ₈	40 ³ / ₄	67 ¹ / ₄	27 ¹ / ₂	11	17	7	9/16
495	48 ⁷ / ₈	78	34 ³ / ₈	1 ¹ / ₈	44 ⁷ / ₈	74	30 ³ / ₈	11	19	7	9/16
545	53 ⁵ / ₈	85 ⁷ / ₈	37 ¹ / ₂	1 ¹ / ₈	49 ⁵ / ₈	81 ⁷ / ₈	33 ¹ / ₂	13	21	7	9/16
605	58 ⁵ / ₈	94 ¹ / ₂	40 ⁷ / ₈	1 ¹ / ₈	54 ⁵ / ₈	90 ¹ / ₂	36 ⁷ / ₈	15	23	9	9/16
665	64 ³ / ₈	103 ¹ / ₂	44 ³ / ₄	1 ¹ / ₈	60 ³ / ₈	99 ¹ / ₂	40 ³ / ₄	15	25	9	9/16
735	70 ⁷ / ₈	114	49	1 ¹ / ₈	66 ⁷ / ₈	110	45	17	29	11	9/16
805	77 ¹ / ₂	126	53 ¹ / ₂	1 ¹ / ₈	73 ¹ / ₂	122	49 ¹ / ₂	19	31	11	9/16

† Dimensions may vary with narrow-width construction.

Tolerance: ± 1/8"

DIMENSIONS [INCHES]					
Model	Inside diameter	Bolt circle	Outside diameter	Standard holes	
				Number	Diameter
245	21 ³ / ₄	23 ¹ / ₂	24 ³ / ₄	16	9/16
275	24 ³ / ₈	26 ¹ / ₈	27 ³ / ₈	16	9/16
305	26 ⁷ / ₈	29 ¹ / ₈	30 ⁷ / ₈	16	9/16
335	29 ¹ / ₂	31 ³ / ₄	33 ¹ / ₂	16	9/16
365	32 ⁷ / ₈	35 ¹ / ₈	36 ⁷ / ₈	16	9/16
405	36 ¹ / ₈	38 ³ / ₈	40 ¹ / ₈	16	9/16
445	40 ¹ / ₈	42 ³ / ₈	44 ¹ / ₈	16	9/16
495	43 ⁷ / ₈	46 ¹ / ₈	47 ⁷ / ₈	24	9/16
545	48 ⁷ / ₈	51 ¹ / ₈	52 ⁷ / ₈	24	9/16
605	53 ⁷ / ₈	56 ¹ / ₈	57 ⁷ / ₈	24	9/16
665	59 ³ / ₈	61 ⁵ / ₈	63 ³ / ₈	24	9/16
735	66 ¹ / ₈	68 ³ / ₈	70 ¹ / ₈	32	9/16
805	72 ⁵ / ₈	74 ⁷ / ₈	76 ⁵ / ₈	32	9/16

Tolerance: ± 1/8"

DIMENSIONS [INCHES] **Not to be used for construction unless certified.**

ALL ARRANGEMENTS

Model	A				B		BB		C	D	DD	F	G	L	M†	P	R†	U	W	a	b		c	d
	TH/TAD	BH/BAU	UB/TAU	DB	*	TAD	*	TAD													BAU/TAU	TAD		
245	20¼	28½	25	20¼	18⅝	25	43½	51⅞	22¾	22½	37	26⅞	19¼	21¾	15	27⅞	9	17	15½	21	31⅞	36¼	24½	17½
275	25¾	31¼	27½	25¾	20½	30¾	48¼	58½	25	24⅞	41	28¾	21⅞	24¾	16⅞	30¼	10	18½	16⅞	23⅞	34¾	42	26⅞	19⅝
305	27¼	34½	30¼	26¼	22½	33¼	53⅞	64⅞	27¾	27⅞	45½	32	23½	26⅞	18½	33½	10⅞	20¼	18⅞	25⅞	38½	45¼	29⅞	21½
335	29½	38½	33¼	26½	24½	36	58⅞	69⅞	30½	30¼	50	35⅞	25⅞	29½	20⅞	37⅞	12¼	22¼	21	28¼	42⅞	50¼	32⅞	23½
365	32¾	42¼	35½	29	29	40¾	66½	78¼	33¾	33½	55¼	38⅞	28⅞	32⅞	22⅞	40⅞	13⅞	24¼	22½	31⅞	48	56⅞	36⅞	26
405	36	46¼	40	31	31	44	72⅞	85⅞	37¼	36⅞	60⅞	42⅞	31⅞	36⅞	24⅞	44⅞	14½	26	23¼	34⅞	52¼	61½	40	28¾
445	39	50¾	44	33½	33½	47¾	79¼	93½	41⅞	40¾	67¼	47¼	34⅞	40⅞	27½	49¼	15¾	28½	25	37⅞	57⅞	67⅞	44¼	31⅞
495	42	55½	48¼	36	36	52	86⅞	102⅞	45½	44⅞	74	52⅞	38¼	43⅞	30⅞	54⅞	17¼	31	26	41¾	62⅞	73⅞	48⅞	34⅞
545	46	61½	53¼	40	40	56¾	95¾	112½	50¼	49⅞	81⅞	57⅞	42⅞	48⅞	33½	60⅞	19¼	33¼	29½	46¼	69	80⅞	53⅞	38½
605	51	67¾	58½	43	43	62½	104⅞	124⅞	55⅞	54⅞	90½	63¾	46⅞	53⅞	36⅞	66¼	21	37¼	31½	51	75½	89⅞	59½	42⅞
665	55	74	64¼	47	47	68	114⅞	135⅞	60⅞	60⅞	99½	70⅞	51½	59⅞	40¾	72⅞	22⅞	40½	33½	56⅞	82¾	97⅞	65½	46⅞
735	See Table for Sizes 735 and 805 below				51½	74½	126½	149½	64¼	66⅞	110⅞	77½	57	66⅞	45	80	25¼	44½	35½	62⅞	91¼	107½	72¼	51⅞
805					57½	65½	140½	148½	74⅞	73½	122⅞	85¾	63	72⅞	49½	88¼	27½	50⅞	42½	68⅞	101¼	106⅞	80	57⅞

SIZES 735 and 805 only – ARRANGEMENTS 7/8

Model	A							Outlet area [sq. ft.]		Wheel diameter [inches]	Wheel circumference [feet]
	TH	BH	UB	DB	TAD	BAU	TAU	Fan	Evasé		
735	64	81½	75¾	51½	60	78½	71	20.5	33.9	73	19.1
805	70	89¾	82⅞	57½	65½	86¼	77⅞	24.8	41.4	80¾	21.1

ARRANGEMENTS 1/4/8

Model	H†	J	K		N	O†		S	T	Base holes
			Arr. 1	Arr. 8		Arr. 1/8	Arr. 1			
245	43½	5	5½	5½	18	38⅞	17⅞	14	8-¾"	—
275	47⅞	5	6	6	20	42½	19⅞	15⅞	8-¾"	—
305	52	5	6½	6	22	46⅞	21⅞	17⅞	8-¾"	—
335	57⅞	6	7	6	24	52	23⅞	19	8-¾"	—
365	63⅞	6	7½	6	27	57¼	13⅞	20½	10-1"	—
405	68⅞	6	8	7	30	62½	14⅞	21¼	10-1"	—
445	75	6	8½	7	33	68⅞	16⅞	23	10-1"	—
495	81⅞	6	9	7	36	74	17⅞	24	10-1"	—
545	90	7	9½	7	40	83⅞	19⅞	27	10-1"	—
605	98⅞	7	10	8	45	91½	22⅞	29	10-1"	—
665	107¼	7	10½	8	49	99⅞	24⅞	31	10-1"	—
735	—	7	—	8	54	—	26⅞	33	—	—
805	—	7	—	9	60	—	29⅞	40	—	—

ARRANGEMENTS 3/7

Model	H†			J	K		N				O†	T‡	Base holes	
	Arr. 3				Arr. 3	Arr. 7	Arr. 3		Arr. 7					
	AF-30	AF-40	AF-50				AF-30	AF-40	AF-50	AF-30				AF-40
245	30½	31½	31½	6	5½	—	4	5	5	—	—	21	14	6-¾"
275	32⅞	33⅞	33⅞	6	6	—	4	5	5	—	—	22⅞	15⅞	6-¾"
305	36	37	37	7	6½	—	4	5	5	—	—	24½	17⅞	6-¾"
335	38⅞	39⅞	40⅞	7	7	—	4	5	6	—	—	28⅞	19	6-¾"
365	42⅞	42⅞	43⅞	7	7½	—	5	5	6	—	—	30⅞	20½	6-1"
405	44⅞	45⅞	45⅞	7	8	—	5	6	6	4	5	32⅞	21¼	6-1"
445	49	50	—	8	8½	—	5	6	—	4	5	35½	23	6-1"
495	52⅞	53⅞	—	8	9	—	5	6	—	5	5	38⅞	24	6-1"
545	58	58	—	9	9½	—	6	6	—	6	6	43½	15¼	10-1"
605	61⅞	62⅞	—	9	10	—	7	6	7	—	6	46⅞	17	10-1"
665	66¼	67¼	—	9	10½	—	8	6	7	—	6	50¾	18⅞	10-1"
735	—	—	—	7	—	—	—	—	—	—	—	—	—	—
805	—	—	—	7	—	—	—	—	—	—	—	—	—	—

ARRANGEMENTS 4/7/8

Model	Frame size	N			NN†			O†			S		SS			Base holes		
		Arr. 4	Arr. 7	Arr. 8	Arr. 4	Arr. 7	Arr. 8	Arr. 4	Arr. 7	Arr. 8	Arr. 4	Arr. 7/8	Arr. 4	Arr. 7	Arr. 8			
245	364TS	21⅞	—	56	39⅞	—	66½	17⅞	27⅞	—	—	—	—	—	—	—		
	365TS	22⅞	—	57	40⅞	—	67½	18⅞	28⅞	—	—	—	—	—	—	—		
	404TS	23⅞	—	58¼	41⅞	—	68¾	19⅞	29⅞	—	—	7-¾"	—	—	—	—		
	405TS	24⅞	—	59¾	42⅞	—	70¼	21⅞	31⅞	—	—	—	—	—	—	11-¾"		
275	404TS	23⅞	—	61¾	43	—	73⅞	19⅞	30⅞	—	—	—	—	—	—	—		
	405TS	24⅞	—	63¼	44½	—	74⅞	21⅞	31⅞	—	—	7-¾"	—	—	—	11-¾"		
	444TS	27¼	—	66¾	47⅞	—	77¾	23¾	34¾	—	—	—	—	—	—	—		
	445TS	29¼	—	68⅞	49⅞	—	79¾	25¾	36¾	—	—	—	—	—	—	—		
305	444TS	27¼	—	69⅞	48¼	—	81⅞	23¼	34¼	—	—	—	—	—	—	—		
	445TS	29¼	—	71⅞	50¼	—	83⅞	25¼	36¼	—	—	7-¾"	—	—	—	11-¾"		
	447TS	32¾	—	74⅞	54¼	—	86⅞	29¼	40¼	—	—	—	—	—	—	—		
	449TS	38¾	—	80⅞	60¼	—	92⅞	35¼	46¼	—	—	—	—	—	—	—		
335	444TS	27¼	—	72⅞	51⅞	—	86¼	23¼	34¼	—	—	—	—	—	—	—		
	445TS	29¼	—	74⅞	53⅞	—	88¼	25¼	36¼	—	—	7-¾"	—	—	—	11-¾"		
	447TS	32¾	—	77⅞	57⅞	—	91¾	28¾	39¾	—	—	—	—	—	—	—		
	449TS	38¾	—	83⅞	63⅞	—	97¾	34¾	45¾	—	—	—	—	—	—	—		
365	364T	21⅞	—	71¼	48	—	86¾	17⅞	29½	—	—	—	—	—	—	—		
	365T	22⅞	—	72⅞	49	—	87¾	18⅞	30½	—	—	7-1"	—	—	—	13-1"		
	404T	23⅞	—	74⅞	49¾	—	89⅞	19⅞	32⅞	—	—	—	—	—	—	—		
	405T	24⅞	—	76⅞	51¼	—	91⅞	20⅞	34⅞	—	—	—	—	—	—	—		
405	404T	23⅞	49¾	79¾	52	66⅞	96⅞	19⅞	33⅞	—	—	—	—	—	—	—		
	405T	24⅞	51¼	81¼	53½	67⅞	97⅞	20⅞	35⅞	—	—	7-1"	—	—	—	13-1"		
	444T	27¼	55	85⅞	56⅞	71½	101½	23¼	39	—	—	—	—	—	—	—		
	445T	29¼	57	87⅞	58⅞	73½	103½	25¼	41	—	—	—	—	—	—	—		
445	444T	27¼	56⅞	89⅞	58¼	74⅞	107⅞	23¼	39	—	—	7-1"	—	—	—	13-1"		
	445T	29¼	58⅞	91⅞	60¼	76⅞	109⅞	25¼	41	—	—	—	—	—	—	—		
	447T	32¾	58⅞	91⅞	64¼	75⅞	108⅞	28¾	40¾	—	—	—	—	—	—	—		
495	445T	29¼	56	92⅞	63⅞	75¼	111¼	25¼	37¼	—	—	7-1"	—	—	—	13-1"		
	447T	32¾	59⅞	95⅞	67⅞	78¼	114¾	28¾	40¾	—	—	—	—	—	—	—		
	449T	38¾	65⅞	101⅞	73⅞	84¾	120¾	34¾	46¾	—	—	—	—	—	—	—		

* For TH, BH, UB, BAU, and TAU discharges. For DB discharge, use A dimension for B. † Dimensions may vary with narrow-width construction. NOTE: For fan Sizes larger than 49, motors typically exceed NEMA frame sizes. Therefore, dimensions must be on application. ‡ This dimension does not apply to the pedestal side on Arrangement 7 fans larger than Size 49. Appropriate base hole dimensions will be furnished on application.

Tolerance: ± 1/8"

ARRANGEMENT 1

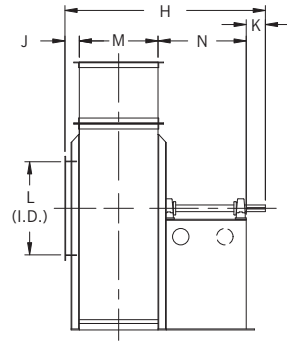

① Omitted on Models 245 through 335.

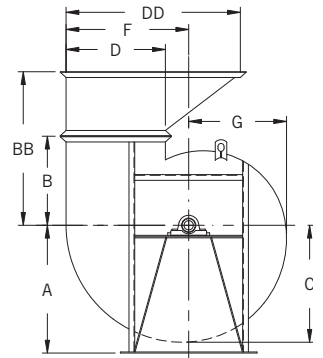
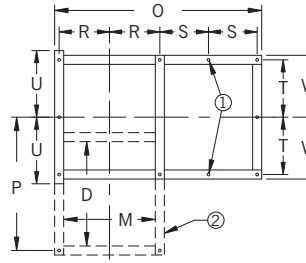

ARRANGEMENTS 3/7

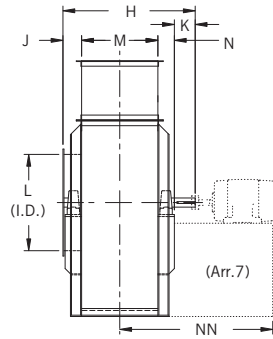

① Omitted on Models 245 through 495.

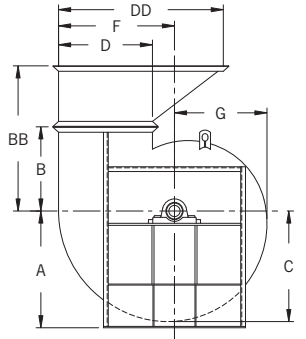
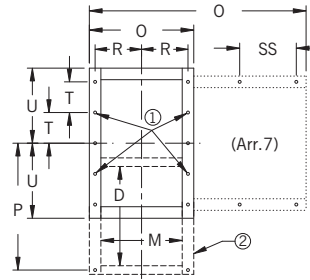

ARRANGEMENT 4

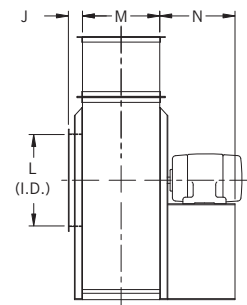

① Omitted on Models with motor frame 405 or smaller.

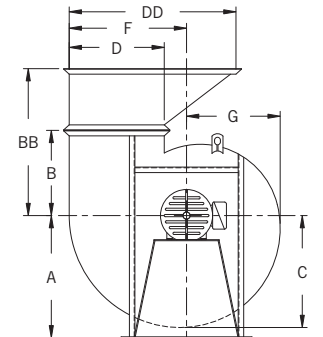
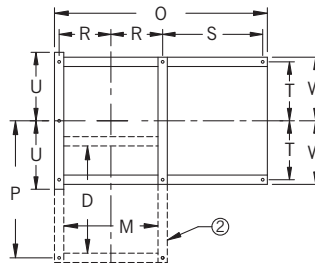

ARRANGEMENT 8

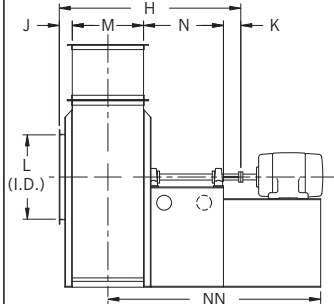

① Omitted on Models 245 through 335.

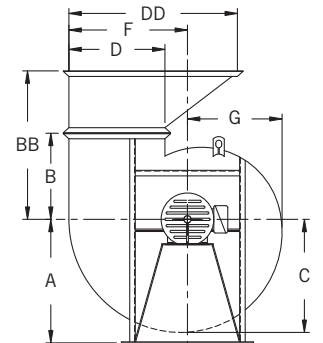
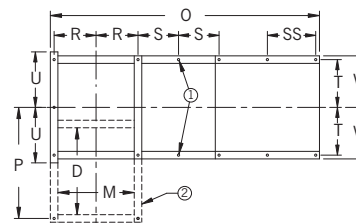

② Base bars form flanged outlet on Down Blast.

M, D, and DD are outside housing dimensions. J is from housing side over inlet. L is inside diameter.

FAN DISCHARGES – VIEWED FROM DRIVE SIDE

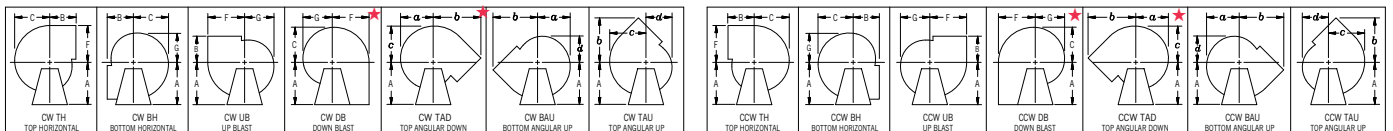

Clockwise—angular discharges at 45°

Counterclockwise—angular discharges at 45°

★ Down Blast and Top Angular Down discharge positions must be evaluated for clearance of accessories such as unitary base, outlet damper, evase, etc. Consult nyb with specific details.

The New York Blower Company has a policy of continuous product development and reserves the right to change designs and specifications without notice.

COMPLETE SELECTION OF AIR-MOVING EQUIPMENT

The New York Blower Company offers thousands of different types, models, and sizes of air-moving equipment. Contact your nyb representative for assistance in identifying the best fan for your application.

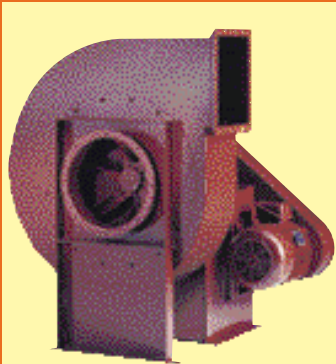

DUST/MATERIAL HANDLING

Wide range of duty available with unique fan lines capable of handling light dust to heavy material. Typical applications include dust-collection and high-pressure process along with material-conveying.



AIR-HANDLING [CENTRIFUGAL]

Designed for clean to moderately dirty gas streams. Commercial and industrial HVAC, process cooling, light material-conveying, heat removal, and dryer exhaust are just a few of the numerous sample applications

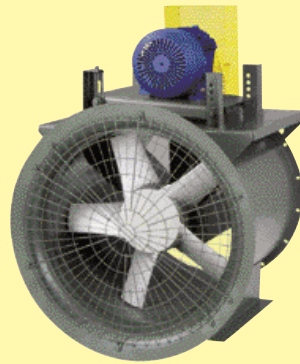

AIR-HANDLING [AXIAL]

For the ideal handling of clean to moderately dirty airstreams. Commercial and industrial HVAC, drying and cooling systems, fume extraction, and process-heat removal are typical applications.



FIBERGLASS REINFORCED PLASTIC [FRP]

Choice of performance and duty for corrosive gas streams. Applications include chemical process, wastewater treatment, laboratory hood exhaust, and tank aeration.

CUSTOM PRODUCTS

Designed for unique applications. Variety of configurations, temperatures, flows, and pressures. Wide range of modifications and accessories are available to meet the most demanding specifications.

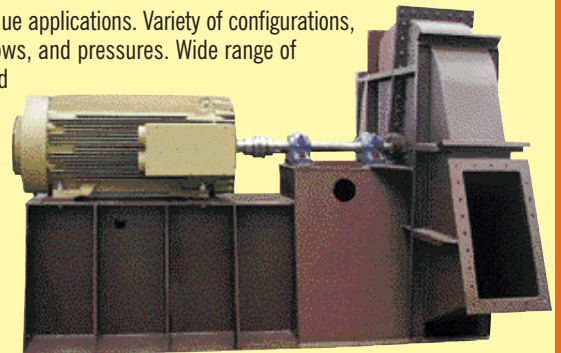

Leading the industry forward since 1889

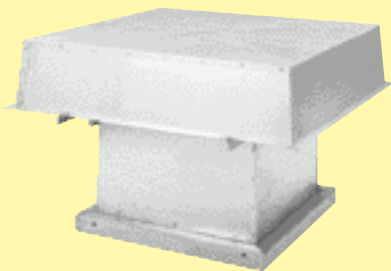

ROOF VENTILATORS

Including both hooded and upblast ventilators, propeller fans, and centrifugal roof exhausters. These units are ideal for industrial, commercial, and institutional applications.

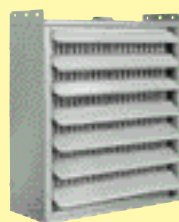

HEATING PRODUCTS

Industrial-duty steam unit heaters with steam heating coils are available for facility heating and process-heat transfer.



PROCESS/FAN COMPONENTS

Plug fans, plenum fans, wheels, inlet cones, and housings for a wide variety of OEM applications. Process/fan components are used in air-handling units, ovens, dryers, freezer tunnels, and filtration systems.